

CE



SANITARY WATER HEAT PUMP WITH WATER TANK

USER-INSTALLER MANUAL

SHERPA

SHW 200

SHW 300S



08	12-2016	A.Bonfante		Inclusion of the specifications of anti-legionella cycle and the conformity.
07	04-2016	A.B.	P.F.	Adding the data for the climate conditions with heat source outside air
06	09-2015	D.P.	G.M.	Chapters / Paragraphs that were modified: 4.1 - 8.4 - 9.5 - 9.6 - 9.6.4 - 11.4.1 - 11.4.6 - 11.5 - 16 - 17 Chapters / Paragraphs that were added: 11.4.8
05	11-2014	D.P.	G.M.	Chapters / Paragraphs that were modified: 9.4 – 11.4.6 – 16 Chapters / Paragraphs that were added: 17
04	05-2014	D.P.	G.M.	/
03	03-2014	D.P.	G.M.	/
02	02-2014	D.P.	G.M.	/
01	01-2014	Andrea M. D.P.	G.M.	/
00	11-2013	D.P.	G.M.	/
Rev	Date	Edited by	Approved by	Notes

Catalogo / Catalogue / Katalog / Catalogue

260409A / MUI14110D6120-08

Serie / Series / Serie / Serie / Série

SHERPA SHW - SANITARY WATER HEAT PUMP

Possible wasted electrical or electronic devices/products should not be located together with normal domestic waste, but disposed according to the current WEEE law in compliance with the European Directive 2012/19/UE. Please inform yourself at your local Administration or at your reseller in case the product will be replaced with a similar one.



INDEX

1	AIM AND CONTENTS OF THIS MANUAL	4
1.1	HOW TO KEEP THIS MANUAL.....	4
1.2	GRAPHIC SYMBOLS USED IN THE MANUAL	4
2	SAFETY LAWS	4
3	PERMITTED USE.....	4
4	GENERAL SAFETY GUIDELINES.....	5
4.1	WORKERS' HEALTH AND SAFETY	5
4.2	PERSONAL SAFETY EQUIPMENTS	5
4.3	SAFETY SYMBOLS.....	5
4.4	REFRIGERANT SAFETY DATA SHEET	6
5	GENERAL CHARACTERISTICS.....	7
5.1	FLEXIBILITY AND BENEFITS OF HEAT PUMP INSTALLATION	7
5.2	COMPACT DESIGN	7
5.3	AVAILABLE MODELS.....	8
5.4	AVAILABLE OPTIONALS.....	8
6	TECHNICAL FEATURES.....	8
7	ITEMS INSIDE PRODUCT BOX	8
8	OVERVIEW OF THE UNIT	9
8.1	PARTS AND DESCRIPTIONS	9
8.2	DIMENSIONS.....	9
8.3	HOLES FOR CABLES	11
8.4	HOW TO REPLACE THE MAGNESIUM STICK.....	11
8.5	REGULATION THERMOSTAT OF THE ELECTRIC HEATER.....	11
8.6	SCHEMATIC OVERVIEW OF THE WATER AND GAS CIRCUIT	12
8.7	SCHEMATIC OVERVIEW OF THE GAS CIRCUIT	12
9	INSTALLATION.....	12
9.1	GENERALITY	12
9.2	SAFETY INSTRUCTIONS	13
9.2.1	<i>Warning</i>	13
9.2.2	<i>Caution</i>	13
9.3	TRANSPORTATION.....	13
9.3.1	<i>Transport using a forklift</i>	13
9.3.2	<i>Manual transport</i>	14
9.4	REQUIRED SERVICE SPACE	14
9.5	INSTALLATION OVERVIEW	15
9.6	HYDRAULIC CONNECTIONS	16
9.6.1	<i>Water connections</i>	16
9.6.2	<i>Water loading</i>	16
9.6.3	<i>Water emptying</i>	17
9.6.4	<i>Installation of an external re-circulation pump and flow switch</i>	17
9.7	ELECTRICAL CONNECTIONS	18
10	START UP	19
11	OPERATION THE UNIT.....	20

11.1	USER INTERFACE.....	20
11.2	OPERATIONS.....	20
11.3	LCD ICONS.....	22
11.4	MAIN LOGICS.....	23
11.4.1	<i>Water temperature difference for compressor starting.....</i>	23
11.4.2	<i>External pump</i>	23
11.4.3	<i>Flow switch</i>	23
11.4.4	<i>Thermal protections</i>	23
11.4.5	<i>Disinfection weekly cycle</i>	23
11.4.6	<i>Electrical heater.....</i>	24
11.4.7	<i>ON/OFF contact.....</i>	25
11.4.8	<i>Contact for photovoltaic plant integration.....</i>	25
11.5	PARAMETER CHECKING AND ADJUSTMENT	26
11.6	MALFUNCTIONING OF THE UNIT AND ERROR CODES	27
12	MAINTENANCE AND PERIODICAL CONTROLS.....	28
12.1	ENVIRONMENTAL PROTECTION	29
13	TROUBLESHOOTING	29
14	WHEN THE UNIT GOES OUT OF SERVICE	29
15	DISPOSAL REQUIREMENTS.....	29
16	TECHNICAL CHARACTERISTICS.....	30
17	WORKING LIMITS OF HEAT PUMP	31
18	WIRING DIAGRAM.....	32
18.1	STANDARD CONNECTION	32
18.2	CONNECTION OF AN AUXILIARY HEAT SOURCE.....	33
18.3	CONNECTION OF AN AUXILIARY HEAT SOURCE BY MEANS OF AN EXTERNAL SWITCH	34
19	FICHE ACCORDING TO REGULATION (EU) NO 812/2013	35
20	TECHNICAL PARAMETERS ACCORDING TO REGULATION (EU) NO 814/2013	35

The SHERPA SHW manual contains all the necessary information for the better use of the equipment under safety conditions for the operator.

1 AIM AND CONTENTS OF THIS MANUAL

This manual provides basic information as for the installation, the operation and the maintenance of SHERPA SHW units. It is addressed to machine operators and it enables them to use the equipment efficiently, even if they do not have any previous specific knowledge of it.

This manual describes the characteristics of the equipment at the time it is being put on the market; therefore, it may not capture later technological improvements introduced by the company as part of its constant endeavour to enhance the performance, ergonomics, safety and functionality of its products.

The company, therefore, is not constrained to update the manuals for previous versions of machines.

It's recommended that the user must follow the instructions contained in this booklet, especially those concerning the safety and routine maintenance.

1.1 HOW TO KEEP THIS MANUAL



The manual has to be always kept with the unit it refers to. It has to be stored in a safe place, away from the dust and moisture. It has to be accessible to all users who shall consult it any time they are in doubt on how to operate the equipment.

The company reserves the right to modify its products and related manuals without necessarily updating previous versions of the reference material. It assumes no responsibility for any inaccuracies in the manual, if due to printing or transcription.

The customer shall store any updated copy of the manual or parts of it delivered by the manufacturer as an attachment to this manual.

The company is available to give any detailed information about this manual and to give information regarding the use and the maintenance of its own units.

1.2 GRAPHIC SYMBOLS USED IN THE MANUAL

	<i>Indicates operations that can be dangerous for people and/or disrupt the correct operation of the equipment.</i>
	<i>Indicates prohibited operations.</i>
	<i>Indicates important information that the operator has to follow in order to guarantee the correct operation of the equipment in complete safety. It indicates also general notes.</i>

2 SAFETY LAWS

SHERPA SHW units have been designed in compliance with the following Directives and Harmonised Norms:

- Community Directives: 2006/95/CE, 2004/108/CE, 2011/65/UE, 2012/19/UE;
- Norms: EN 60335-2-21/A2, EN 60335-2-40/A2, EN 60335-1/A14; EN 62233;
- Norms: EN 55014-1/A1, EN 55014-2/A2, EN 61000-3-2/A2, EN 61000-3-3.

3 PERMITTED USE

- The company excludes any contractual and no-contractual liability for damage caused to persons, animals or things, by incorrect installation, adjustment and maintenance, improper use or a partial or superficial reading of the informations contained in this manual.
- These units have been designed for water heating. A different application, unless expressly authorized by the manufacturer, is to be considered improper and therefore not allowed.
- The location and the hydraulic and electric plant should be determined by the system designer and must take into account both the purely technical needs as any applicable local legislations and specific authorizations.
- The execution of all work must be performed by qualified and experienced personnel, competent in the existing rules in different countries

4 GENERAL SAFETY GUIDELINES

Before beginning to operate on SHERPA SHW units every user has to be perfectly knowledgeable about the functions of the equipment and its controls and has to have read and understood the information listed in this manual.

	<i>It's strictly forbidden to remove and/or tamper with any safety device.</i>
	<i>Do not remove the grills on the fan outlet and top cover.</i>
	<i>It' forbidden the use by children and unassisted disabled persons.</i>
	<i>Do not touch the appliance when barefoot or with wet or damp parts of the body.</i>
	<i>Do not pull, detach or twist the electrical cables coming from the unit, even if it is disconnected from the mains supply.</i>
	<i>Do not stand with your feet on the device, sit down and/or lean on any type of object.</i>
	<i>Do not spray or pour water directly on the device.</i>
	<i>Not dispose of, abandon or leave within reach of children packaging materials (cardboard, staples, plastic bags, etc.). because it can be a potential source of danger.</i>
	<i>Any routine or not-routine maintenance operation shall be carried out when the equipment has been shut down, disconnected from electric power sources.</i>
	<i>The plastic cover can be removed only by qualified operators.</i>
	<i>Do not put neither your hands nor insert screwdrivers, spanners or other tools into moving parts of the equipment.</i>
	<i>The equipment supervisor and the maintenance man has to receive suitable training for the performance of their tasks in safety.</i>
<i>Operators have to know how to use personal protective devices and have to know the accident-prevention guidelines contained in national and international laws and norms.</i>	

4.1 WORKERS' HEALTH AND SAFETY

The European Community has adopted a number of directives on workplace's health and safety, which include 89/391/CEE, 89/686/CEE, 2009/104/CE, 86/188/CEE and 77/576/CEE directives. Every employer shall implement such provisions and ensure that workers respect them:

	<i>Do not tamper with or replace parts of the equipment without the specific consent of the manufacturer. The manufacturer shall have no responsibility whatsoever in case of unauthorised operations.</i>
	<i>Using components, expendable materials or spare parts that do not correspond to those recommended by the manufacturer and/or listed in this manual may be dangerous for the operators and/or damage the equipment</i>
	<i>The operator's workplace has to be kept clean, tidy and free from objects that may prevent free movements. Appropriate lighting of the work place shall be provided so as to allow the operator to carry out the required operations safely. Poor or too strong lighting can cause risks.</i>
	<i>Ensure that work places are always adequately ventilated and that aspirators are working, in good condition and in compliance with the requirements of the laws in force.</i>

4.2 PERSONAL SAFETY EQUIPMENTS

When operating and maintaining the SHERPA SHW units, use the following personal protective equipments.

	<i>Protective clothing: Maintenance men and operators has to wear protective clothing that complies with the basic safety requirements currently in force. In case of slippery floors, users have to wear safety shoes with non-slip soles.</i>
	<i>Gloves: During maintenance or cleaning operation protection gloves have to be used</i>
	<i>Mask and goggles: Respiratory protection (mask) and eye protection (goggles) should be used during cleaning and maintenance operations.</i>

4.3 SAFETY SYMBOLS

The unit features the following safety signs, which has to be complied with:

	<i>General hazards</i>
	<i>Electric shock hazard</i>
	<i>Presence of moving organs</i>
	<i>Presence of surfaces that may cause injuries</i>

4.4 REFRIGERANT SAFETY DATA SHEET

Name:	R134a (100% ,1,1,2-Tetrafluoroethane).
RISK INDICATIONS	
Major risks:	Asphyxia.
Specific risks:	The rapid evaporation may cause freezing. It can cause cardiac arrhythmia.
FIRST AID	
General informations:	Never give anything by mouth to an unconscious person.
Inhalation:	Move to fresh air. Oxygen or artificial respiration if necessary. Do not administer adrenaline or similar drugs.
Eyes contact:	Rinse carefully with water for at least 15 minutes and consult a doctor.
Contact with skin:	Wash immediately with plenty of water. Take off immediately the contaminated clothing.
FIRE PREVENTION	
Extinguishing Media:	Whatever.
Specific risks:	Increase in pressure.
Specific methods:	Use water spray to cool containers
Special protective equipments:	Use breathing apparatus in confined spaces.
ACCIDENTAL RELEASE ACTIONS	
Personal precautions:	Evacuate personnel to safe areas. Provide adequate ventilation. Use personal protective equipment.
Environmental precautions:	Evaporate.
Cleaning method:	Evaporate.
HANDLING AND STORAGE	
Manipulation actions/technical precautions:	Provide sufficient air exchange and/or suction in workplaces.
Recommendations for safe use:	Do not breathe vapors or aerosol. Do not apply any testing pressure with air/HFC-134a mixtures. It may form with the air a fuel mixture at pressures greater than atmospheric greater than atmospheric pressure when the volume ratio exceeds 60%.
Storage:	Close tightly and store in a cool, dry and well ventilated place. Store in original container. Incompatible products: explosive, flammable materials, organic peroxide.
EXPOSURE CONTROL / PERSONAL PROTECTION	
Control parameters:	AEL (8-h e 12-h TWA) = 1000 ml/m ³ .
Respiratory protection:	For rescue and maintenance operation in storage tanks use self-contained respirator apparatus. The vapors are heavier than air and can cause suffocation by reducing oxygen available for breathing.
Eyes protection:	Total safety glasses.
Protection of hands:	Rubber gloves.
Hygiene measures:	Do not smoke.
PHYSICAL AND CHEMICAL PROPERTIES	
Colour:	Colourless liquefied gas.
Odor:	Similar to ether.
Boiling point:	-26.5°C at atmospheric pressure.
Lighting point:	It does not ignite.
Density:	1.21 kg/l at 25°C.
Solubility in water (wt %):	0.15
STABILITY AND REACTIVITY	
Stability:	No reactivity when used with the appropriate instructions.
Materials to avoid:	Alkali metals, alkaline earth metals, powdered metals, metal salts.
Dangerous decomposition products:	Halogen acids, carbon dioxide (CO ₂), carbon monoxide, fluorocarbons, carbonyl halides.
Dangerous reactions:	The product is not flammable in contact with air under ambient conditions of temperature and pressure. When pressurized with air or oxygen the mixture may become flammable. Certain mixtures of HCFCs or HFCs with chlorine may become flammable or reactive under certain conditions.
TOXICOLOGICAL INFORMATION	
Acute toxicity:	LC50/ inhalation /4 hours/on rat >2085 mg/m ³
Local effects:	Concentrations substantially above the TLV (1000 ppm) may cause narcotic effects. Inhalation of decomposed products at high concentrations may cause respiratory failure (pulmonary edema).
Long term toxicity:	Did not show carcinogenic, teratogenic or mutagenic effects in animal experiments. It can cause cardiac arrhythmia. Threshold limit for the cardiac sensitivity: 312975 mg/m ³ . Threshold limit for the anesthetic effects: 834600 mg/m ³ .
ECOLOGICAL INFORMATION	
Global warming potential GWP (R11=1):	1430
Potential depletion Ozone ODP (R11=1):	0
Disposal considerations:	usable with reconditioning.

5 GENERAL CHARACTERISTICS

The hot water heat pump is one of the most economical systems to heat the water for family domestic use or for small business activities. Using free renewable energy from the air, the unit is highly efficient with low running costs. Its efficiency can be up to 3~4 times more than conventional gas boilers or electrical heaters.

5.1 FLEXIBILITY AND BENEFITS OF HEAT PUMP INSTALLATION

Waste heat recovery: the unit can be installed near the kitchen, in the boiler-room or the garage, basically in every room which has a large number of waste-heat so that it has the higher energy efficiency even with very low outside temperatures during the winter.



Hot water and dehumidification: the unit can be placed in the laundry room or clothing room. When it produces hot water it lowers the temperature and dehumidifies the room as well.



Storage room cooling: the unit can be placed in the storage room as the low temperature helps to keep the food fresh.

Hot water and fresh air ventilation: the unit can be placed in the garage, gym, basement etc. When it produces hot water, it cools the room and supplies fresh air.

Compatible with different energy sources: the unit can work with a second heat source as solar panels, external heat pumps, boilers or other different energy sources (remark: the extra heat source is not provided with).

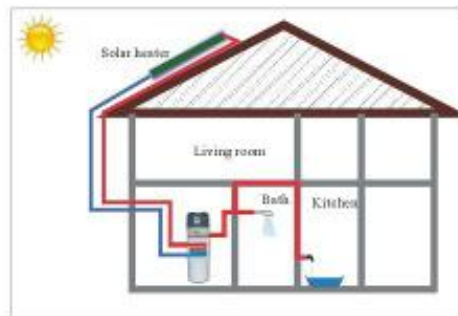

Ecological and economical heating: the unit is one of the most efficient and economical alternatives to both fossil fuel boilers and heating systems. By making use of the renewable source in the air, it consumes much less energy.

Multiple functions: the special design of the air inlet and outlet makes the unit suitable for various ways of connections. With different ways of installation, the unit can work as just a heat pump but also as a fresh air blower, a dehumidifier, or an energy recovery device.

 ***The function for which the unit has been designed is only that of heat pump for DHW production. Any other side effect (ambient cooling, dehumidification, waste heat recovery) should be considered as a perk, on which you can not have however precise control. The performance data will therefore be provided only with respect to the function of water heating.***

5.2 COMPACT DESIGN

The unit is especially designed for offering sanitary hot water for family use. Its extremely compact structure and elegant design are suitable for indoor installation.

5.3 AVAILABLE MODELS

To adapt to different installation requirements, the SHERPA SHW unit is available in 2 versions:

- **SHERPA SHW 200:** standard that provides the heat pump and the electric heater as heating sources;
- **SHERPA SHW 300S:** with auxiliary coil for use in combination with solar panels;

5.4 AVAILABLE OPTIONALS

The optionals are available (not provided) only for SHW 300S model and they are necessary to manage solar integration or hot sanitary water re-circulation:

- **B0841:** 1”F flow switch;
- **B0842:** temperature probe with 5 m cable.

6 TECHNICAL FEATURES



- ✓ Steel tank with double layer vitrification.
- ✓ Anti-corrosion magnesium stick for assuring the durability of the tank.
- ✓ Condenser wrapped externally to the boiler, free from fouling and gas-water contamination.
- ✓ High thickness polyurethane foam (PU) thermal insulation (42 mm).
- ✓ Outer shell made of grey colour RAL 9006 plastic material.
- ✓ Acoustically isolated top part plastic cover.
- ✓ Highly efficient compressor with the R134a refrigerant.
- ✓ High and low gas pressure protections.
- ✓ Electrical heater available in the unit as a back-up (with integrated thermo cut out with protection set at 90°C), assuring constant hot water even in extreme cold winters.
- ✓ ON-OFF contact for starting the unit from an external switch.
- ✓ Weekly disinfection cycle.
- ✓ Possibility of manage hot sanitary water re-circulation or solar water integration (presence of a dedicated temperature probe, flow switch input and command for an external pump).



Acoustically isolated plastic cover

7 ITEMS INSIDE PRODUCT BOX

Before starting the installation, please make sure that all parts are found inside the box.

The Unit Box		
Item	Image	Quantity
Domestic hot water heat pump		1
Operation and Installation Manual		1

8 OVERVIEW OF THE UNIT

8.1 PARTS AND DESCRIPTIONS

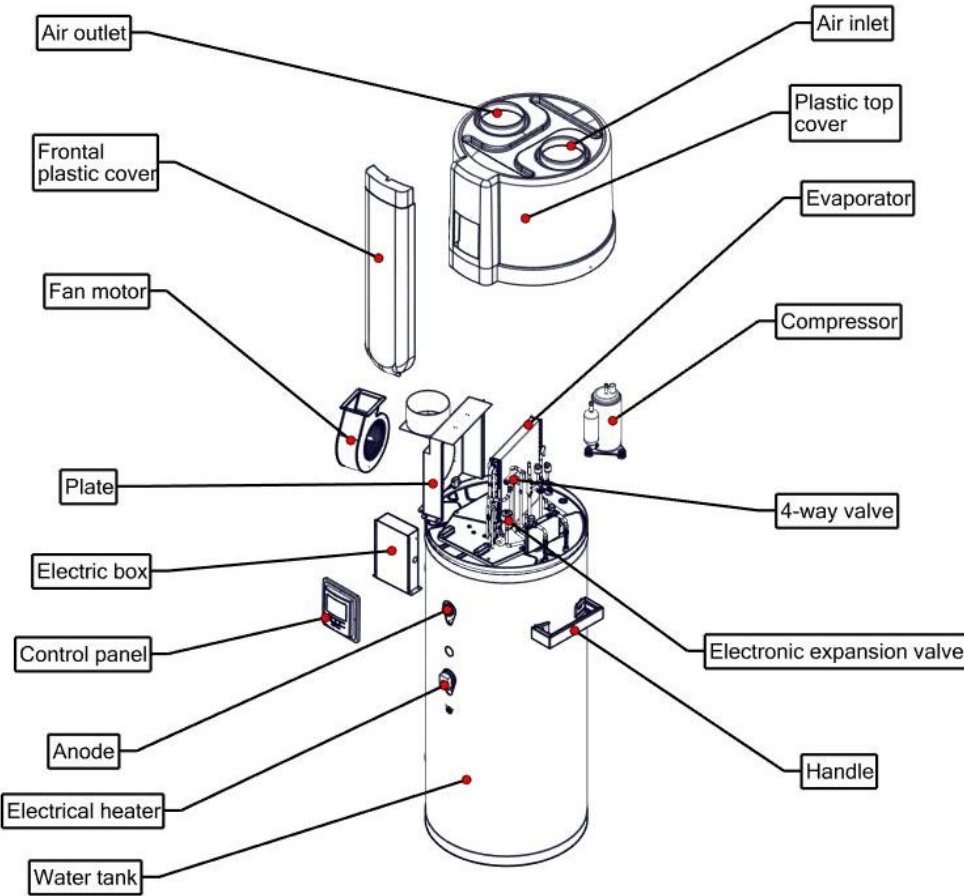

8.2 DIMENSIONS

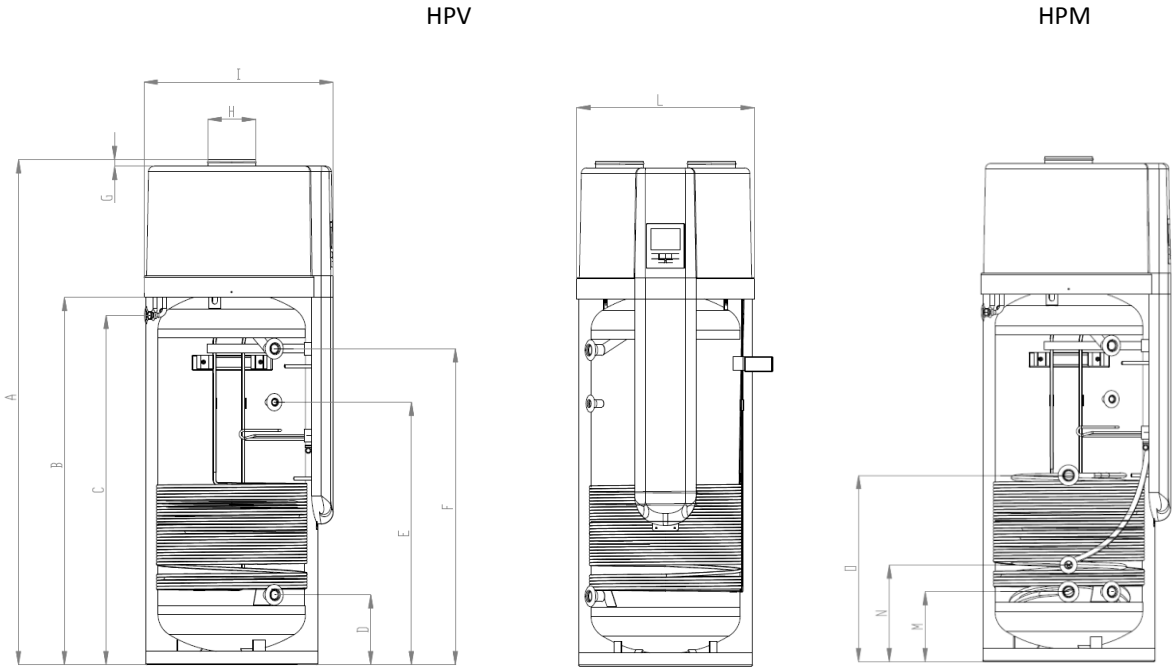

Dimensions [mm]	SHW 200	SHW 300S
A	1638	1888
B	1124	1374
C	1062	1312
D	262	
E	747	982
F	932	1182
G	25	
H	φ 177	
I	706	
L	φ 654	
M	-	262
N	-	357
O	-	697

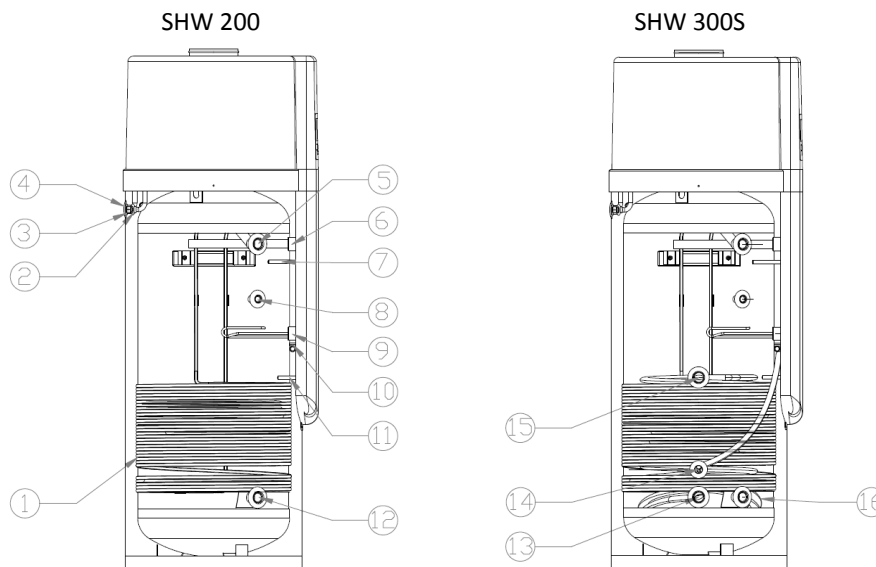

POS.	DESCRIPTIONS	DIMENSIONS	
		SHW 200	SHW 300S
1	Aluminium heat exchanger	3/8"	3/8"
2	Hole for auxiliary cables	Φ 17 mm	Φ 17 mm
3	Hole for power supply	Φ 17 mm	Φ 17 mm
4	Condensate drain	Φ 22 mm x 0,3 m	Φ 22 mm x 0,3 m
5	Hot water outlet	G 1" female	G 1" female
6	Anti-corrosion magnesium stick	1" ¼ female	1" ¼ f female
7	Upper tank temperature (T3) + thermostat T85°C	Φ 12 mm x L 120 mm	Φ 12 mm x L 120 mm
8	Connection for re-circulated water	G ½" female	G ½" female
9	1200 W auxiliary electric heater with integrated thermostat	1" ¼ female	1" ¼ female
10	Grounding	M6	M6
11	Lower tank temperature (T2)	Φ 12 mm x L 90 mm	Φ 12 mm x L 90 mm
12	Cold water inlet	G 1" female	G 1" female
13	Solar water outlet	G 1" female	G 1" female
14	Auxiliary tank temperature	/	Φ 12 mm x L 90 mm
15	Solar water inlet	G 1" female	G 1" female
16	Solar exchanger coil	1,2 m ²	1,2 m ²

8.3 HOLES FOR CABLES

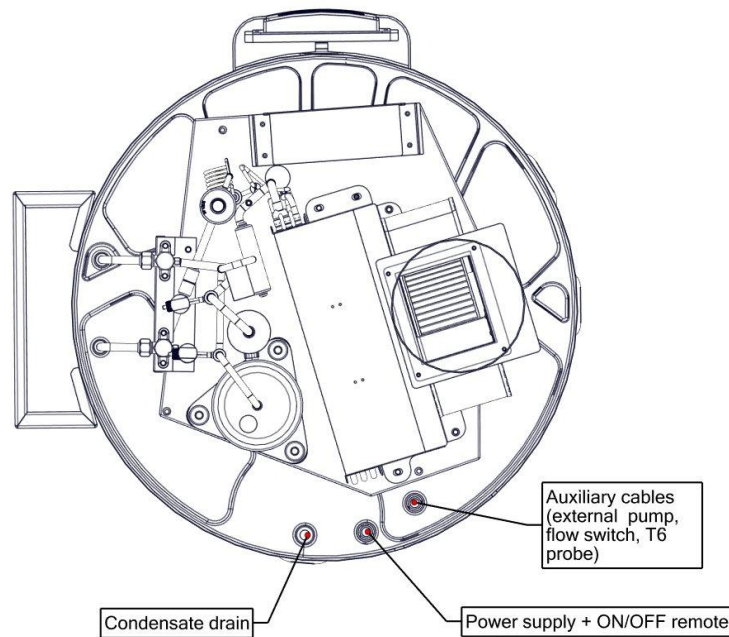

8.4 HOW TO REPLACE THE MAGNESIUM STICK

The Magnesium stick is an anti-corrosion element. It is assembled in the water tank to avoid the creation of fur around the inside tank and to protect the tank, and other components. It can help to extend the life-span of the tank.

Check the magnesium stick every year and change it if it has the diameter less than 22 mm, clean it if it is intact but encrusted by limestone.

- Turn the power of the unit 'OFF' and pull out the plug.
- Drain all the water out of the tank.
- Remove the old magnesium stick from the tank.
- Replace the new magnesium stick.
- Recharge the water.



8.5 REGULATION THERMOSTAT OF THE ELECTRIC HEATER

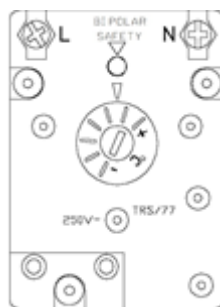

The auxiliary electric heater is equipped with a regulation thermostat; the access to this component takes place by removing the plastic frontal cover. Such control allows a variation of temperature between 15 and 75°C; each notch corresponds to a temperature variation of 10°C.

The factory setting is set to its maximum value, 75°C, a modification of this value is not recommended as it would produce malfunctions on the legionella cycle control (For this purpose it is required to read carefully the paragraph **Errore. L'origine riferimento non è stata trovata.**).

8.6 SCHEMATIC OVERVIEW OF THE WATER AND GAS CIRCUIT

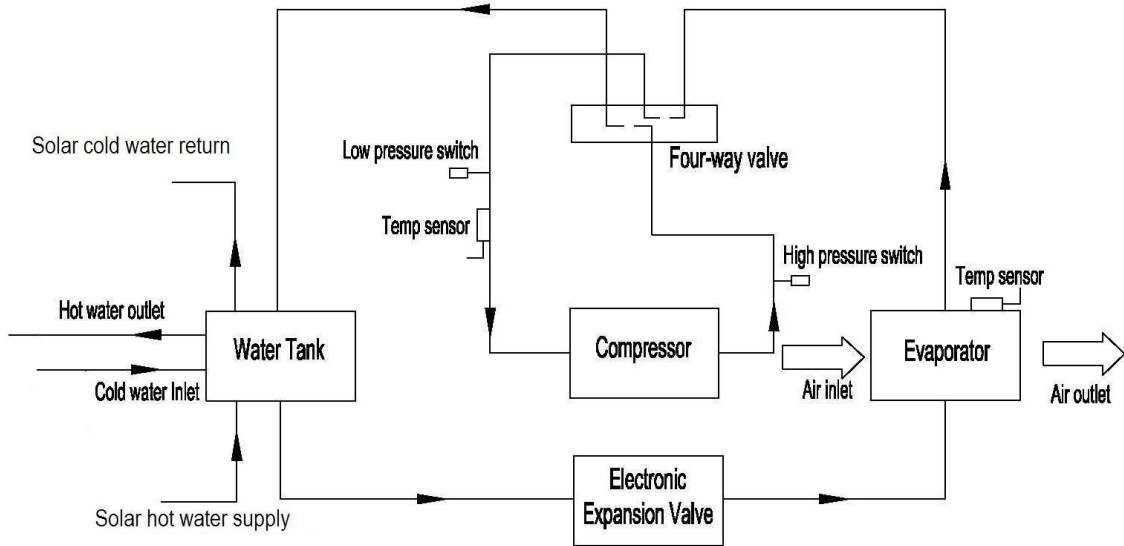

8.7 SCHEMATIC OVERVIEW OF THE GAS CIRCUIT

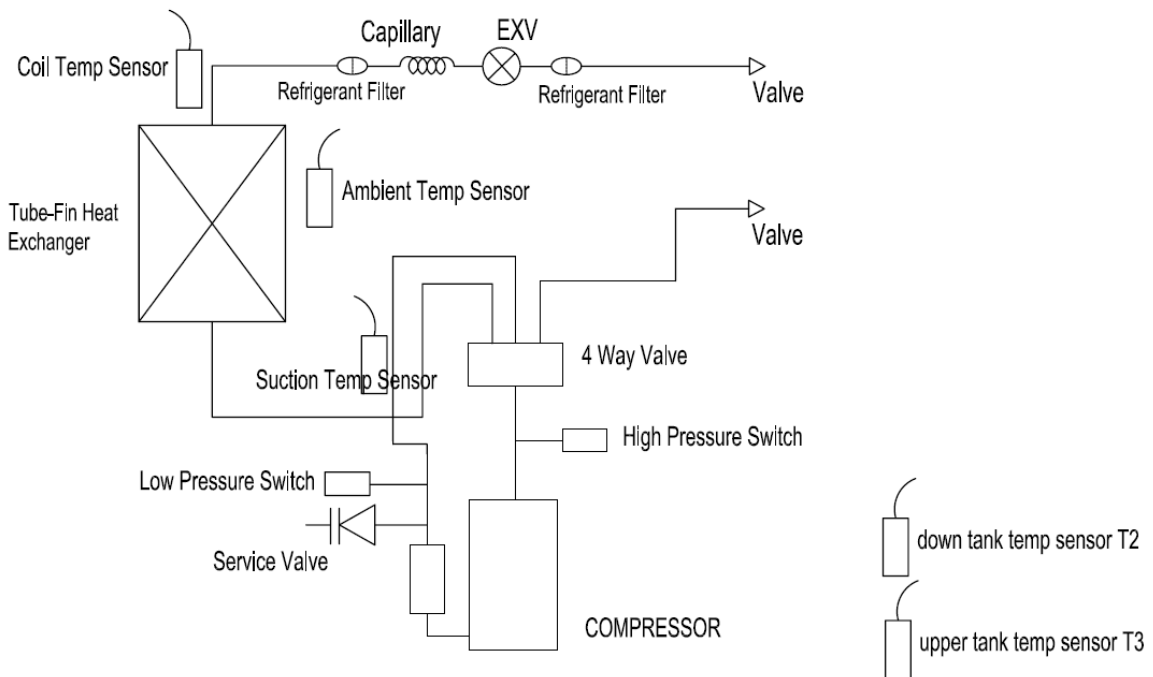

9 INSTALLATION

WARNING: All the operations described below must be carried out only by **QUALIFIED PERSONNEL**. Prior to any work on the unit, make sure that the power supply is disconnected.

9.1 GENERALITY

When installing or servicing the unit, it is necessary to strictly follow the rules listed in this manual, to conform to all the specifications of the labels on the unit, and to take any possible precautions. Not observing the rules reported on this manual can create dangerous situations.

After receiving the unit, immediately check its integrity. The unit left the factory in perfect condition; any eventual damage has to be questioned to the carrier and recorded on the Delivery Note before signing it.

The company has to be informed, within 8 days, of the extent of the damage. The Customer should prepare a written statement of any severe damage.

Please note that all the installation diagrams shown in this chapter are only a guide. The correct installation plant must be evaluated case by case by the installer.

9.2 SAFETY INSTRUCTIONS

To prevent injury to the user, other people, or property damage, the following instructions must be followed. Incorrect operation due to ignoring of instructions may cause harm or damage.

Install the unit only when it complies with local regulations, by-laws and standards. Check the main voltage and frequency. This unit is only suitable for earthed sockets, connection voltage 220 - 240 V ~ / 50Hz.



The following safety precautions should always be taken into account:

- be sure to read the following **WARNING** before installing the unit;
- be sure to observe the cautions specified here as they include important items related to safety;
- after reading these instructions, be sure to keep it in a handy place for future reference.

9.2.1 Warning

	The unit must be securely fixed to avoid noise and shaking: when insufficiently installed, the unit could fall causing injury. The bearing surface should be flat to bear the weight of the unit and suitable for installing the unit without increasing noise or vibration. In the place where there is strong wind, fix the unit in the location protected from the wind.
	When installing the unit in a small room, please take measures (like sufficient ventilation) to prevent the asphyxia caused by the leakage of refrigerant.
	Be sure to use the provided or specified parts for the installation work: the use of defective parts could cause an injury due to possible fire, electric shocks, the unit falling etc.
	Do not tear off the labels on the unit: the labels are for the purpose of warning or reminding, keeping them can ensure your safe operations.
	Indoor installation is compulsory: it is not allow to install the unit at outdoor or rain achieving place.
	The installation place without direct sunlight and other heat supplies is recommended: if no way to avoid these, please install a covering.
	Make sure that there's no obstacles around the unit.

9.2.2 Caution

	Do not install the unit in a place where there is a chance of flammable gas leaks: if there is a gas leak and gas accumulates in the area surrounding the unit, it could cause an explosion.
	Do not clean the unit when the power is 'ON': always shut 'OFF' the power when cleaning or servicing the unit. If not, it could cause an injury due to the high speed running fan or an electrical shock.
	In case the unit is used without air ejection duct, verify that the installation room has got a volume not less than 20m³, with adequate ventilation. Please note that the temperature of the expelled air is 5-10°C lower than the inlet air, therefore if not channelled it can cause a significant lowering of the temperature of the installation room.
	Do not continue to run the unit when there is something wrong or there is a strange smell: the power supply needs to be shut 'OFF' to stop the unit; otherwise this may cause an electrical shock or fire.
	Inside the unit, there are some moving parts. Be especially careful when working near them, even if the unit is off.
	The temperatures of heads and exhaust piping of the compressor are usually high. Therefore be careful when working near condensing coils.
	The aluminum fins are very sharp and can cause serious injuries.

9.3 TRANSPORTATION

As a rule, the unit is to be stored and/or transported in its shipping container in upright position and without water charge. During the transport (provided that it is done with care) and the storage, it's advisable to not exceed an inclination angle of 30 degrees max. If all possible precautions are taken in order the unit is not damaged, and only for transport on particularly short distances, it is possible to position the unit horizontally. Particular attention must be taken during loading operations: all the machines must be loaded and stowed in the truck interposing suitable spacers for safeguarding all protruding parts such as water connections and resistance. Ambient temperatures of -20 to +70 degrees Celsius are permitted.

9.3.1 Transport using a forklift

When transported by a forklift, the unit must remain mounted on the pallet. The lifting rate should be kept to a minimum. Due to its top-heaviness, the unit must be secured against tipping over. To prevent any damage, the unit must be placed on a level surface.

9.3.2 Manual transport

For the manual transport, the wooden pallet can be used. Using ropes or carrying straps, a second or third handling configuration is possible. With this type of handling, it is advised that the maximum permissible inclination angle of 45 degree is not exceeded. If transport in an inclined position cannot be avoided, the unit should be taken into operation one hour after it has been moved into final position.

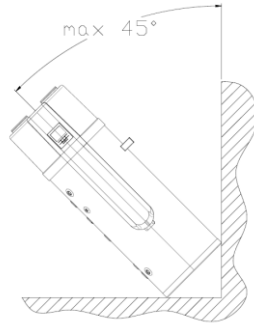

	<p>ATTENTION: due to the high center of gravity, low overturning moment, the unit must be secured against tipping over.</p>
	<p>ATTENTION: the cover of the unit cannot withstand stress, so it cannot be used for transport.</p>
	<p>ATTENTION: the unit can be inclined only on the opposite side of the handle (see above drawing), in other words only on the left side respect of the control panel.</p>

The unit is equipped with a handle to facilitate transport. The handle is supplied unassembled: in case of need, it shall be fixed with two M8 screws to the two threaded inserts.



9.4 REQUIRED SERVICE SPACE

Below you will find the minimum space required to be able to complete service and maintenance tasks on the units. Moreover, recirculation of discharge air has to be avoided; failure to observe this point will result in poor performance or activation of safety rolls. For these reasons it is necessary to observe the following

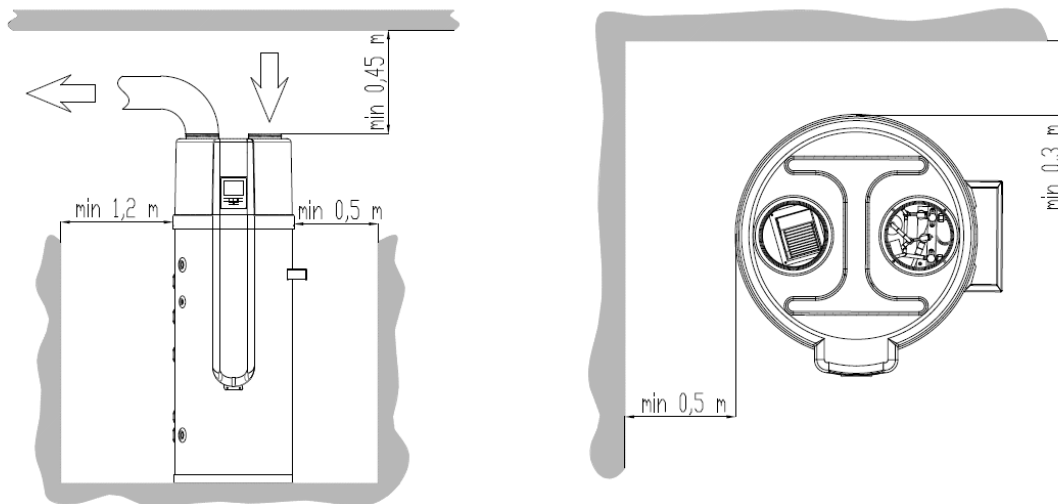

clearances.

	<i>If air inlet and/or outlet pipes are connected, portion airflow and capacity in heat pump unit will lose.</i>
	<i>If the unit connects with air ducts it should be DN 180 mm for pipes or 180 mm internal diameter flexible hose. Total length of the ducts should not be longer than 8 m or the maximum static pressure should not exceed than 60 Pa. If the air ducts are bended, the pressure loss will be larger. So if there are 2 bending pipes, the total length of the ducts should not be longer than 4m.</i>
	<i>Please note that the performance of the unit are reduced in the case the air inlet is connected to a duct which takes air from outside, because of the low winter temperatures and high summer temperatures. The optimal working ambient temperature is 20°C.</i>

In the table on this side, the max lengths of air piping are reported, depending on the geometry and if the installer need to reduce the diameter to 160 mm.

Max lenght of air piping (in+out)		d = 180 mm	d = 160 mm
Without curves		8 m	4,3 m
90° curves no.	1	6,9 m	3,2 m
	2	5,9 m	2,2 m
	3	4,9 m	/
	4	4 m	/

9.5 INSTALLATION OVERVIEW

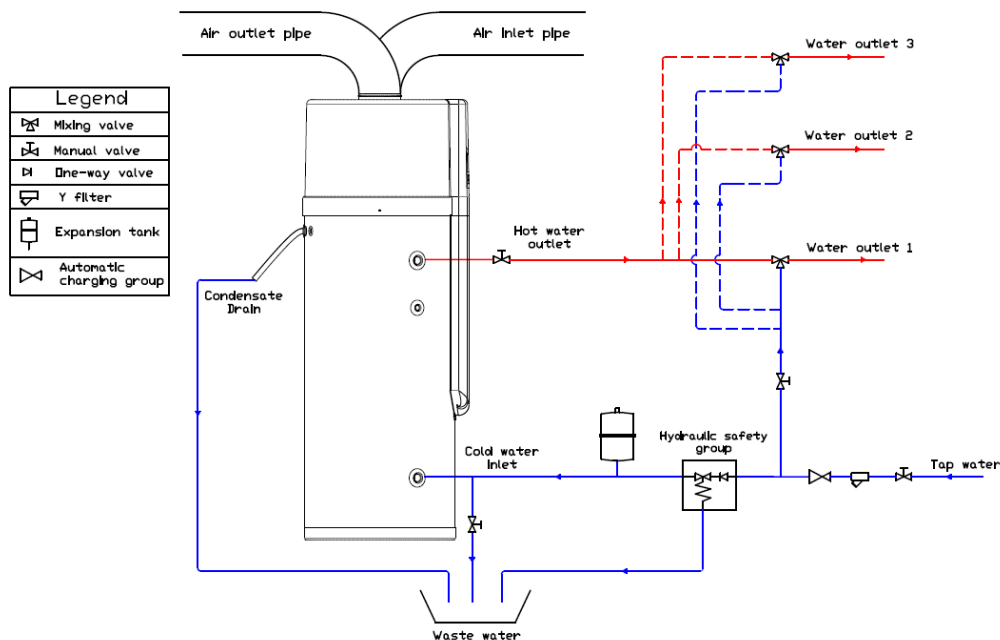



	<i>An hydraulic safety group complying with EN 1487 standards must be installed in the water inlet. If not, it could cause damage to the unit, or even hurt people. The safety group must be provided with stop valve, manual drain valve, inspectionable non-return valve and safety valve set to 7 bar. For the installation place please refer to the pipeline connection sketch. The safety group must be protected from frost.</i>
	<i>The discharge pipe connected to the safety group is to be installed in a continuously downward direction and in a frost-free environment. Ensure the water may drip from the discharge pipe of the safety group and that this pipe must be left open to the atmosphere.</i>
	<i>The safety group is to be operated regularly to remove lime deposits and to verify that it is not blocked. Please beware of burn, because of the high temperature of water.</i>
	<i>The expansion tank with capacity suitably sized to absorb volume variations (depending from the extension of sanitary distribution piping) must be installed in the inlet line. In each case, its capacity must not be lower than 12 L for 200 series and 18 L for 300 series.</i>
	<i>The tank water can be drained through the external manual gate valve installed on the inlet pipe (not provided).</i>
	<i>After all the pipes installed turn on the cold water inlet and hot water outlet to fill the tank. When there is water normally flowing out from water outlet taps, the tank is full. Turn off all valves and check all pipes. If any leakage, please repair.</i>
	<i>If the inlet water pressure is less than 1.5 bar, a pressure pump should be installed at the water inlet. For ensure the long safety using age of tank at the condition of water supply hydraulic higher than 5.5 bar, a reducing valve should be mounted at the water inlet pipe.</i>
	<i>A filter is advisable in the air inlet. If the unit is connected with ducts, filter in there must be put forward to the air inlet of duct.</i>
<i>To fluently drain condensate water from evaporator, please install the unit at the horizontal floor with a maximum inclination angle of 2 degrees towards the discharge hole that is located on the opposite side of the control panel. Otherwise, please make sure the condensate drain pipe is at the lowest place and make a siphon on it if necessary.</i>	

9.6 HYDRAULIC CONNECTIONS

The hydraulic connections have to be installed in accordance with national and local regulations. Pipes can be made up of multilayer pipe, polyethylene or stainless steel and must withstand at least 100°C and 10 bar. Pipes have to be designed depending on the desired water flow and on the hydraulic pressure drops of the system. All pipes have to be insulated with closed-cell material of adequate thickness. Units should be connected to piping by means of flexible joints. Piping should include:

- Y-shaped metallic filter (to be mounted on the inlet pipe) with a mesh not larger than 1mm.
- Automatic charging group (3 bar advised) when water supply pressure is higher than 5,5 bar.
- Hydraulic safety group (7 bar).
- Manual gate valves to separate the unit from the hydraulic circuit.
- Manual gate valve on the inlet pipe to discharge the unit if necessary.
- Thermometers for wells to monitor the system’s temperature.
- Expansion tanks, safety valves and air vents where indicated in the following installation diagrams.

	<p>Perform the connections making sure that weight of the pipes do not overload the unit.</p>
	<p>Check the water hardness, which should not be below 15°f. With particularly hard water, it’s recommended the use of a water softener so that the residual hardness is no more than 20°f and no less than 15°f.</p>
	<p>WARNING: When it’s possible, connect the pipes to the hydraulic connections always using the system key against key.</p>
	<p>WARNING: Unit water inlet pipe have to be in correspondence with the blue connection, otherwise the unit malfunction could occur.</p>
	<p>WARNING: It is compulsory to install on the WATER INLET connection a metallic filter with a mesh not larger than 1 mm. Should the filter not be installed, the warranty will no longer be valid. The filter have to be kept clean, so make sure it is clean after the unit has been installed, and then check it periodically.</p>
	<p>WARNING: if an external pump is installed and connected to the system (for hot sanitary water circuitation or solar water circuitation) it is recommended to install and connect also a flow switch before the pump. If not, any damage to the pump will not be signalled and the system malfunction could occur.</p>
	<p>Perform the drainage/piping work according to the installation instruction. If there is a defect in the drainage/piping work, water could leak from the unit and household goods could get wet and be damaged.</p> <p>The hot water needs to mix with cold water for terminal usage, too hot water (over 50°C) in the heating unit may cause injury. It’s recommended the use of anti-scald valves.</p>

	<p>The diagrams are to be considered only for indication purpose. It is always required the study of the specific installation context and the approval of the system by a qualified heating engineer designer.</p>
---	--

9.6.1 Water connections

Please pay attention to the below points when connecting the water loop pipe:

- 1) Try to reduce the water loop resistance.
- 2) Make sure there is nothing in the pipe and the water loop is smooth, check the pipe carefully to see if there is any leak, and then pack the pipe with the insulation.
- 3) Install the hydraulic safety group in the water inlet.
- 4) Install also an expansion tank suitably sized to absorbe volume variations.
- 5) The nominal pipe diametere must be selected on the basis of the available water pressure and the expected pressure drop within the piping system.
- 6) The water pipes may be of the flexible type. To prevent corrosion damage, make sure that the materials used in the piping system are compatible.
- 7) When installing the pipe-work on the customers’ site, any contamination of the piping system must be avoided.

9.6.2 Water loading

If the unit is used for the first time or used again after emptying the tank, please make sure that the tank is full of water before turning on the power.

- 1) Open the cold water inlet and hot water outlet.
- 2) Start the water loading. When there is water normally flowing out from the hot water outlet, the tank is full.
- 3) Turn off the hot water outlet valve and water loading is finished.

	<p>ATTENTION: Operation without water in water tank may result in damage of auxiliary e-heater.</p>
--	--

9.6.3 Water emptying

If the unit needs cleaning, moving etc, the tank should be emptied.

- 1) Close the cold water inlet
- 2) Open the hot water outlet and open the manual valve of drainpipe
- 3) Start the water emptying.
- 4) After emptying, close the manual valve.

9.6.4 Installation of an external re-circulation pump and flow switch

If necessary to re-circulate solar water or hot sanitary water, an external pump and flow switch must be connected and installed hydraulically and electrically. The max available output for the pump is 5 A resistive. Also the optional probe T6 must be connected to the electrical box and correctly positioned on the hydraulic plant (see the diagrams here below). The Parameter no. 14 must be configured by the installer (1= hot sanitary water circulation, 2= solar water circulation).

The circulation of hot sanitary water is useful to avoid water becomes cold in the sanitary circuit if not used for several time. In this way the hot water will be always ready when requested.

The circulation of solar water is possible only if solar panel are installed and only for SHW 300S. In this way solar energy is used as secondary heat source to save energy.

In case of solar water circulation, on the circulation loop is required:

- ✓ an expansion tank suitably sized to absorb volume variations, installed before the solar system
- ✓ a pressure safety valve (3 bar) installed after the solar system
- ✓ an air vent valve with manual gate installed near the safety valve

The discharge of the pressure safety valve must be directed to a specific tank for the collection of glicolated water, and not to the normal waste water.

In case of solar water circulation, on the hot water outlet is highly recommended a thermal discharge safety valve (85°C) with its probe positioned into a ½" temperature well installed in the circulation connection.

The SHERPA SHW 300S is provided with an auxiliary well for the installation of any external temperature probe for managing the solar integration with a separated control. In this case, it is recommended to pass the temperature probe through the hole for auxiliary cables (see Paragraph 8.3) and through the conduit arranged to the back of the frontal plastic cover, which is in connection with the auxiliary well. In this way the cable, entering from the rear of the unit, will not be in view thus preserving the aesthetics of the machine. To remove the frontal plastic cover, simply unscrew the two bottom fixing screws and remove the cover from the top cover. To remove the top cover, unscrew the three screws that secure the cover to the tank (one on the rear and two on the sides).

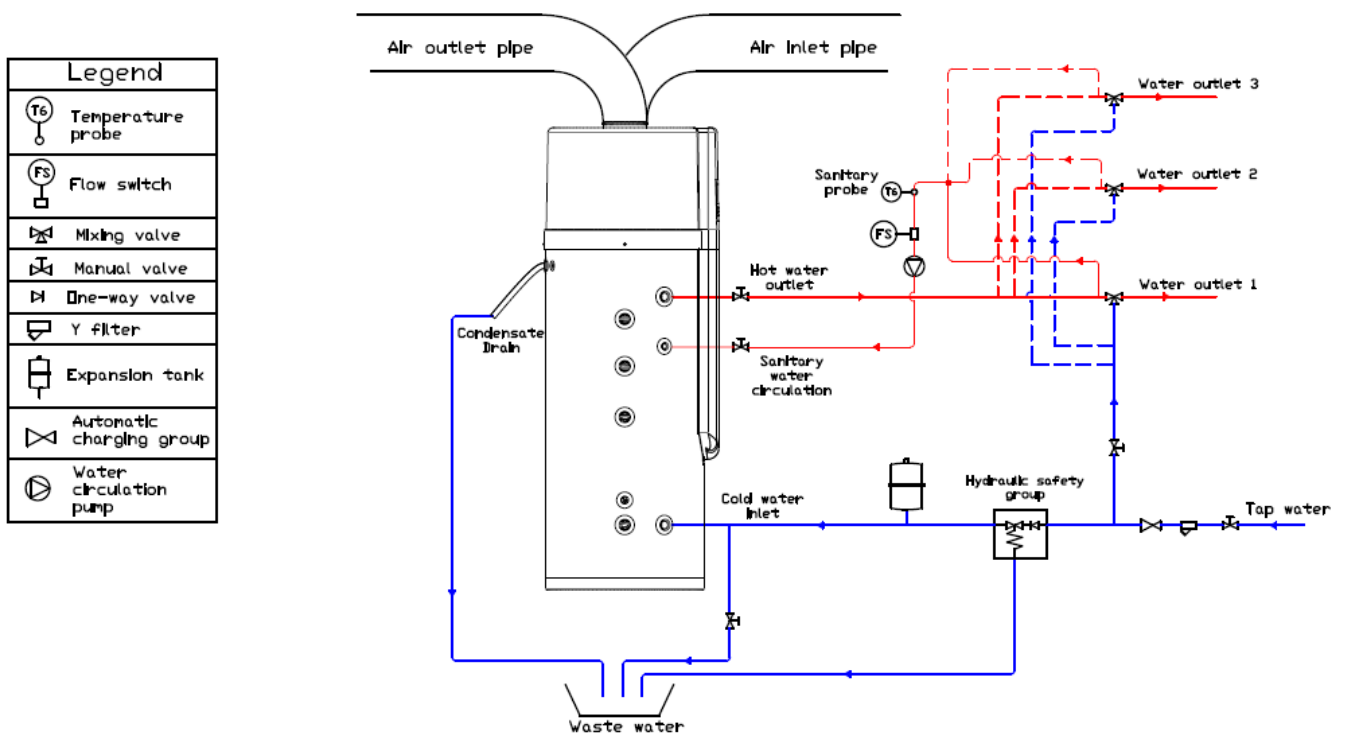

Installation diagram in case of hot sanitary water circulation

Legend	
	Temperature probe
	Flame switch
	Mixing valve
	Manual valve
	One-way valve
	Y filter
	Expansion tank
	Safety valve (3 bar)
	Vent valve
	Thermal discharge safety valve (85°C)
	Automatic charging group
	Water circulation pump

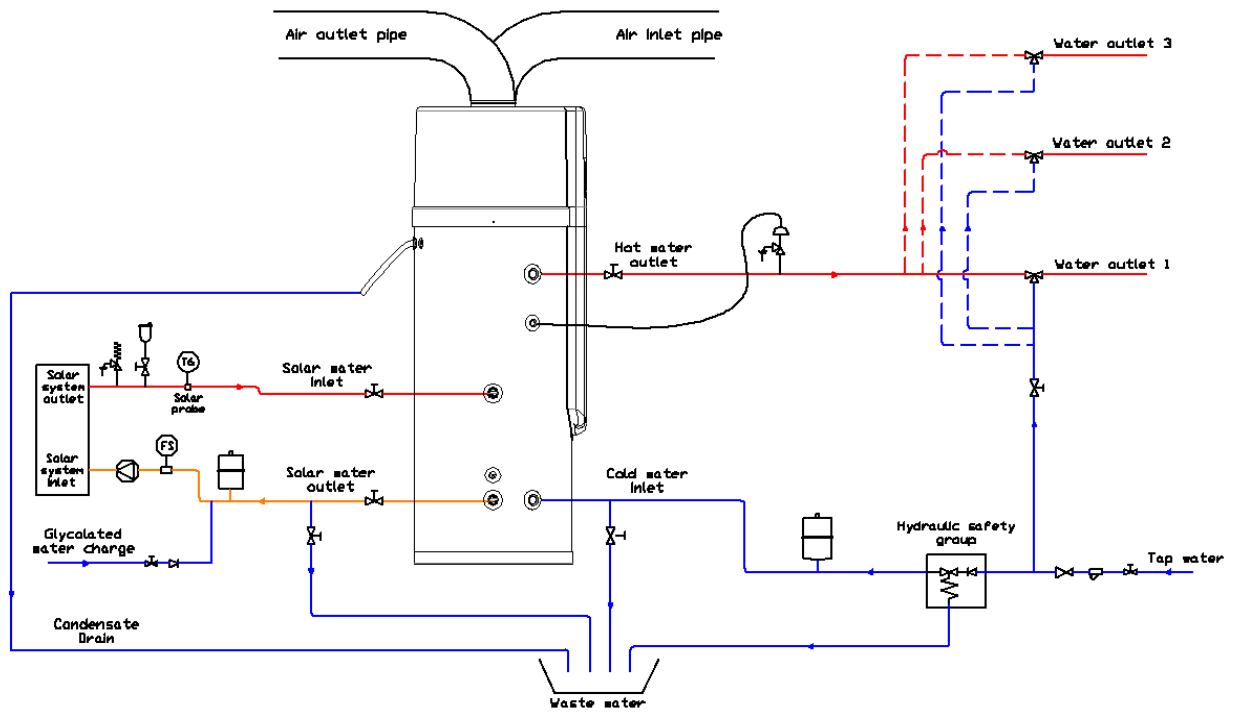

Installation diagram in case of solar water circulation
 Note: solar heat exchange coil is present only in SHW 300S unit

9.7 ELECTRICAL CONNECTIONS

Check out that the power supply meets the unit’s electric nominal data (tension, phases, frequency) reported on the technical label of the unit. Power connections have to be made in accordance to the wiring diagram enclosed with the unit and in conformity with the national and international norms in force (providing equipments as general magnetothermic circuit breaker, differential circuit breakers for each electric line, proper grounding for the plant, etc.). Power cables, electric protections and line fuses have to be sized according to the specifications listed in the wiring diagram enclosed with the unit and in the electrical data contained in the table of technical characteristics (see Paragraph 16).

	WARNING: The power supply have to respect the listed limits: failing this, warranty will terminate immediately. Before any operation on the unit, be sure that the power supply is disconnected.
	WARNING: The supply voltage’s fluctuations can not exceed $\pm 10\%$ of the nominal value. Should this tolerance not be respected, please contact our technical department.
	WARNING: If external circulation pump is connected to the system, the external water flow switch have ALWAYS to be connected following the indications listed in the wiring diagram. Never bridge the water flow switch connections in the terminal board.
	Use the specified electrical wires and attach the wires firmly to the terminal board (connection in such a way that the stress of the wires is not applied to the sections): incorrect connection and fixing could cause a fire.
	Perform electrical work according to the installation manual and be sure to use a dedicated section, fused with 16A. If the capacity of the power circuit is insufficient or there is an incomplete electrical circuit, it could result in a fire or an electric shock.
	The unit must always have an earthed connection. If the power supply is not earthed, you may not connect the unit.
	Never use an extension cable to connect the unit to the electric power supply. If there is no suitable, earthed wall socket available, have one installed by a recognized electrician.
	Do not move/repair the unit by yourself. If the supply cord is damaged, it must be replaced by the manufacturer or its service agent or a similarly qualified person in order to avoid a hazard. Improper movement or repair on the unit could lead to water leakage, electrical shock, injury or fire.
	The installation height of power supply should be over 1.8m, if any water may spatter, the unit can be safe from water.

To access the electrical box:

- 1) remove the plastic cover of the top part
- 2) remove the metallic cover of the electrical box unscrewing the 4 screws
- 3) the unit is already provided with a power supply cable connected to the electrical box. If it's necessary to disconnect it and to connect a longer cable, or if it's necessary to connect an ON/OFF remote signal, or an external flow switch and pump for circulating sanitary water or solar water, please refer to the wiring diagram.

The specification of the power supply wire is $3 \times 1.5 \text{ mm}^2$. Fuse specification is T 3.15A 250V.

There must be a switch when connecting the unit to the power system. The current of the switch is 10A.

A creepage breaker must be installed near the power supply and the unit must be effectively earthed. The specification of the creepage breaker is 30mA, less than 0.1sec.

10 START UP

Before start-up:

- Check out the availability of the supplied wiring diagram and manual of installed apparatus.
- Check out the availability of the electrical and hydraulic diagram of the plant in which the unit is installed.
- Check out that all water connections are properly installed and all indications on unit labels are observed.
- Check the inlet water pressure, make sure that the pressure is sufficient (above 1,5 bar).
- Check that the shut-off valves of the hydraulic circuit are open.
- Verify that the hydraulic circuit has been charged under pressure and air vented.
- Check if any water flows out from the hot water outlet, make sure that the tank is full of water before turning on the power.
- Ensure that arrangements have been provided to drain the condensate.
- Check out that all power cables are properly connected and all terminals are hardly fixed.
- Check that electrical connections are carried out according to the norms in force including grounding.
- Check out that the voltage is the one shown in the unit technical label.
- Make sure the voltage is within the limits ($\pm 10\%$) of tolerance range.
- Check out that there is no refrigerant leakage.
- Check out that all the cover panels are installed in the proper position and locked with fastening screws before start up.
- Check the unit; make sure everything is ok before turning 'ON' the power of the unit, check the light on the wire controller when the unit runs.
- Use the wire controller to start the unit.
- Listen to the unit carefully when turning 'ON' the power of the unit. Turn the power 'OFF' when you hear an abnormal sound.
- Measure the water temperature, to check the undulation of the water temperature.
- Once the parameters have been set, the user cannot change the parameters optionally. Please use a qualified service person to do this.



WARNING: Never switch off the unit (for a temporary stop) by switching off the main switch: this component should be used to disconnect the unit from the power supply only for long stoppages or maintenance/repairing operations.

WARNING: Do not modify the internal wiring of the unit otherwise the warranty will terminate immediately.

11 OPERATION THE UNIT

11.1 USER INTERFACE

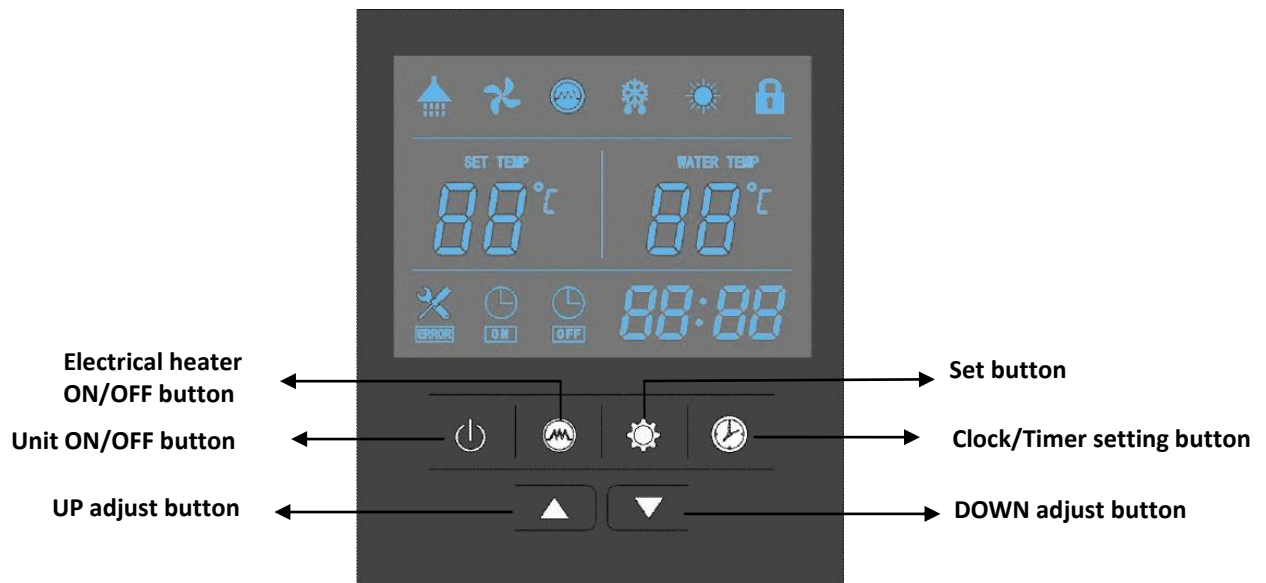

11.2 OPERATIONS

1. Power 'ON'

When turning 'ON' the power, whole icons are displayed on the controller screen for 3 seconds. After checking if everything is ok, the unit enters into the standby mode. Water temperature and clock time are displayed on the screen.



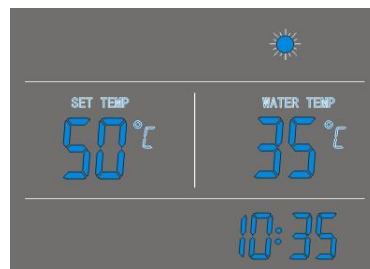

2. button

By pressing this button for 2" when the unit is in standby mode, the unit is turned 'ON' and runs on the setting mode. The running mode, set temperature and water temperature, clock time and timer situation are displayed on the screen.









By pressing this button for 2" again when the unit is running, the unit is turned 'OFF' and enters into the standby mode.

3. and buttons

- These are the multi-purpose buttons. They are used for temperature setting, parameter setting, parameter checking, clock adjustment and adjustment of the timer.
- During running status, press  or  button to adjust the setting temperature directly.
- By pressing these buttons when the unit is on clock setting status, the hour(s) and the minute(s) of the clock time can be adjusted.
- By pressing these buttons when the unit is on timer setting status, the hour(s) and the minute(s) of the timer 'ON'/'OFF' can be adjusted.
- Check and adjust the set parameters:
 - 1) When the unit is 'OFF' or 'ON' (not on clock and timer setting status), short press  button to entry the user

parameter checking. Select the parameter by pressing ▲ or ▼ button. Press  to exit.

- 2) When the unit is 'OFF' (not on clock and timer setting status), press  and  buttons together for 2" and insert the password confirming each field with  button to entry the installer parameter setting. Select the parameter by pressing ▲ or ▼ and short press  button to access the parameter value. Press ▲ or ▼ button to adjust the value and confirm with  button. Press  to exit.

For example: parameter 01, the relating value is 5°C:





 **Once the parameters have been set; the user cannot change the parameters optionally. Please ask a qualified service person to do this when required.**

- By pressing ▲ and ▼ buttons at the same time and hold for 5 seconds, the buttons are locked.
- By pressing ▲ and ▼ buttons at the same time and hold for 5 seconds again, the buttons are unlocked.





4. and buttons

Clock setting:

- Press  button to entry the clock setting interface: hour icon "88:88" flashes;
- Press the ▲ and ▼ buttons to set the exact hour(s) and press  to confirm: minute icon "88:88" flashes;
- Press the ▲ and ▼ buttons to set the exact minute(s) and press  to confirm and exit.

The set clock time is displayed.

Timer setting:

- Press  button for 5" to entry the timer setting interface: timer 'ON' hour icon "88:88" flashes;
- Press the ▲ and ▼ buttons to set the exact hour(s) and press  to confirm: timer 'ON' minute icon "88:88" flashes;
- Press the ▲ and ▼ buttons to set the exact minute(s) and press  to confirm: timer 'OFF' hour icon "88:88" flashes;
- Press the ▲ and ▼ buttons to set the exact hour(s) and press  to confirm: timer 'OFF' minute icon "88:88" flashes;
- Press the ▲ and ▼ buttons to set the exact minute(s) and press  to confirm.

Timer 'ON' and timer 'OFF' icons are displayed near the clock time.

Press  button to cancel the timer settings during the timer 'ON' and timer 'OFF' programming, returning in this way to clock time visualization.

The timer settings are repeating and are still valid after a sudden power cut.

5. button

Press this button to turn 'ON' or turn 'OFF' the electrical heater. The electrical heater will work according to the control program.

When the unit is 'ON', press this button for 5" to enable or disable the fan ventilation function.

6. Error codes

During standby or running status, if there is a malfunction, the unit will stop automatically and show the error code on the right screen of the controller.

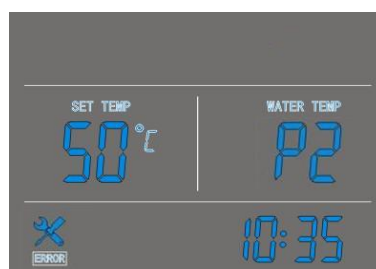

11.3 LCD icons

1. Hot water available

The icon indicates that the domestic hot water temperature reaches the set point. The hot water is available for use. Heat pump is standby.

2. Fan ventilation

The icon indicates that the fan ventilation function is enabled.

By pressing the  button and hold it for several seconds the fan ventilation function can be enabled or disabled. If this function is enabled the fan will continue working to ventilate the air, when the water temperature reaches the set point and unit is standby. If this function is disabled the fan will stop, when the water temperature reaches the set point and unit is standby.

3. Electrical heating

The icon indicates that the electrical heating function is enabled. The electrical heater will work according to the control program. The icon flashes during a disinfection cycle.

4. Defrosting

The icon indicates that the defrosting function is enabled. This is an automatic function, the system will entry or exit the defrosting according to the inner control program. The defrosting parameters cannot be changed at fieldwork. And the unit does not support manual defrosting control.

5. Heating

The icon indicates that the current operation mode is heating.

6. Key lock

The icon indicates the key lock function is enabled. The keys cannot be operated until this function is disabled.

7. Left temperature display

The display shows the setting water temperature.

When checking or adjusting the parameters, this section will display the relating parameter number.
In case any malfunction occurs, this section will display the related error code.

8. Right temperature display

The display shows the current top part part temperature of the water tan.

When checking or adjusting the parameters, this section will display the related parameter value.

9. Time display

The display shows the clock time or timer time.

10. Timer 'ON'

The icon indicates that the timer 'ON' function is enabled.

11. Timer 'OFF'

The icon indicates that the timer 'OFF' function is enabled.

12. Error

The icon indicates there is malfunction.

11.4 MAIN LOGICS

11.4.1 Water temperature difference for compressor starting

Parameter 1 "water temp. difference TS6" is used to control the compressor on or off.

When down tank temperature T2 is lower than setting temperature TS1-TS6, the compressor will work to heat the water until reaching the setting temperature TS1. On the display the top part temperature T3 of the water tank is always visualized.

11.4.2 External pump

T2: lower tank temperature

T3: upper tank temperature

Checks to be done to use the external pump:

- parameter 14 has been configured;
- the optional probe T6 has been electrically and hydraulically connected;
- the external flow switch (optional) has been electrically and hydraulically connected;
- an external pump (not provided) has been electrically and hydraulically connected.

When used for sanitary hot water circulation, the pump will start when the below conditions are satisfied at the same time:

1. Wired controller is ON;
2. $T3 \geq \text{parameter 15} + \text{parameter 16}$;
3. $T6 \leq \text{parameter 15} - 5^{\circ}\text{C}$

The pump will stop when one of the below conditions is satisfied:

1. Wired controller is OFF;
2. $T3 \leq \text{parameter 15} - 2^{\circ}\text{C}$;
3. $T6 \geq \text{parameter 15}$

When used for solar water circulation, the pump will start when the below conditions are satisfied at the same time:

1. Wired controller is ON;
2. $T6 \geq T2 + \text{parameter 17}$
3. $T2 \leq 78^{\circ}\text{C}$

The pump will stop when one of the below conditions is satisfied:

1. Wired controller is OFF;
2. $T6 \leq T2 + \text{parameter 18}$
3. $T2 \geq 83^{\circ}\text{C}$

Pump anti-block function: when the pump stops for 12 hours, it will be forced to run for 2 min.

11.4.3 Flow switch

After the pump is running for 30 sec, if the water flow switch signal is checked to OFF for 5 sec, the pump stops. The pump will restart after 3 min. If this malfunction occurs 3 times in 30 min, the pump can not start until the unit is re-powered. The relating error code will be shown on the controller. Only the pump will be stopped but not the unit itself.

11.4.4 Thermal protections

First step protection: when the tank water goes up to 85°C , the unit will stop and the relating error code will be shown on the controller. This is an auto-reset protection. When tank water temperature goes down, the unit can start again.

Second step protection: when the tank water keeps going up and reaches 90°C , the manual reset cut-off will be active, the electrical heater stops, unless you manual reset the protector.

To manual reset the protector, remove the frontal plastic cover and press the reset red button on the thermostat.

11.4.5 Disinfection weekly cycle

The unit is programmed to activate a weekly anti-Legionella cycle for a period of 30 minutes that brings the tank water to 70°C . This system allows to reduce the risk due to bacteria that causes various diseases, commonly known as "Legionella". It 's recommended to read this paragraph and to ask explanations to your installer/plant designer in order to be properly informed about the risk of spreading this disease. We strongly advised you to read the "Guidelines for prevention and control of legionnaires' disease - Approved in the State-Regions Conference of May 7, 2015- Italy and subsequent amendments, which must be taken as a reference for designing the plant.

The operation of the disinfection cycle is as follows:

The heater will start each week at the setting time (parameter 13) automatically, regardless if the machine is **ON** or in standby mode (i.e. the unit is off but remains connected to the power supply)

When upper tank temperature $T3 \geq \text{TS3}$ (parameter 4), the heater stops. When $T3 \leq \text{TS3} - 2^{\circ}\text{C}$, the heater starts.





The water temperature T3 is kept in range $\text{TS3} - 2^{\circ}\text{C}$ to TS3 for the set disinfection time $t2$ (parameter 5), then the unit quits the disinfection.

When parameter 5 ($t2$) is set to 0, the disinfection function is disabled.

The logic starts to calculate t2 only when T3 has reached TS3.

It's possible to set the interval between the disinfection cycles (parameter 21).

If the unit is "OFF"(and also if ON/OFF contact is opened), the disinfection starts with the same logic of "ON" unit.

	<p><i>If the unit is disconnected from the power supply, the disinfection cycle will not occur. If the unit is left without power supply for longtime, DO NOT use the water contained inside. It is recommended to empty the tank and the water contained inside the pipes of the DHW system. It is also recommended that you let the water flowing for enough time across the pipes not only for renewing all the water but also for washing the pipes themselves. This required "washing" time is inversely proportional to the temperature of the water flowing in the pipes. After cleaning and renewing all the water contained inside the unit and in the pipes of the system, you should proceed with a disinfection.</i></p>
	<p><i>The disinfection cycle occurs only inside the water tank. Therefore, it's recommended to perform a recirculation of the water system especially for disinfecting all the contained water. If cannot be possible, according to the preceding warning, it is recommended to let the water system to flow for a enough for cleaning the pipes and renewing the water.</i></p>
	<p><i>If the parameter 5 (t2) is set to be 0, the disinfection function is disabled. Such operation is strictly unrecommended; the manufacturer declines any responsibility for the data caused by a lack or incorrect unit disinfection. If you desire to disable the disinfection cycle, you should ask the maintainer about the consequences that may arise from this operation</i></p>
	<p><i>It is strictly forbidden to change the default value of parameter 4. The parameters 4 and 5 control the anti-legionella cycle (temperature versus time). We recommend to respect the above guidelines, if you want to change them. Please remember that to keep the temperature of the tank water between 55-60°C in order to inhibit the bacterial proliferation (see Annex 13 of the guidelines mentioned above).</i></p> <p><i>The parameter 21 acts on the frequency of disinfection cycles. It must be properly set according to the storage temperature of the tank and the frequencies of DHW utilization. Higher frequency of the disinfection cycle, results in a lower possibilities of bacteria contact.</i></p> <p><i>The stagnant water allows Legionella bacteria to grow. For this reason it is necessary to properly valuate the frequency of the disinfection cycle according to its own uses.</i></p> <p><i>The plant designer must keep in mind the legionella risk and should adopt all the measures for prevention and control of water.</i></p>

11.4.6 Electrical heater

E-heater turned ON or OFF condition 1:

(when the unit is turned on, and the E-heater button on the control panel hasn't been turned on manually)

1. ON: when the tank water setting temperature TS1 (parameter 0) is bigger than the working limit that is expressed in Paragraph 17, the lower tank temperature T2 has reached this limit and the upper tank temperature $T3 \leq TS1 - 3^{\circ}C$;
OFF: when the upper tank temperature T3 reaches the setting temperature $TS1 + 1^{\circ}C$.
2. ON : when the ambient temperature $\leq -10^{\circ}C$ or $> 44^{\circ}C$;
OFF : when the ambient temperature $\geq -8^{\circ}C$ or $< 42^{\circ}C$.
3. ON : when there is high pressure or low pressure protection for 3 times in 30 min;
OFF : when the third time pressure protection occurs, the error code will be displayed, and this protection can not be recovered unless powering off the supply. So the E-heater keeps running to reach the setting temperature, then it is switched off.
4. ON : when in defrosting (only if the parameter 20 is set to 1=on) or disinfection;
OFF : when exit defrosting or disinfection.

	<p><i>The integration function of the electrical heater that is described at point 1 of condition 1 can be disabled by parameter 32 (see Paragraph 11.5).</i></p>
---	---

E-heater turned ON or OFF condition 2:

(when the unit is turned on, and the E-heater button on the control panel has been turned on manually)

1. ON : compressor runtime exceeds the E-heater delay time (parameter 3), and the upper tank water temperature $T3 \leq TS2 - 3^{\circ}C$;
OFF : upper tank water temperature $T3 \geq TS2 + 1^{\circ}C$.

E-heater turned ON or OFF condition 3:

(when the unit is turned off)

1. ON : if the E-heater button on the control panel has been turned on manually when the unit is at OFF status, the E-heater will work until the tank water T3 reaches the setting temperature TS2;
 OFF : the E-heater button on the control panel has been turned off manually or the tank water T3 reaches the setting temperature TS2.
2. ON : upper tank water temperature $T3 \leq 5^{\circ}\text{C}$ (tank water frozen protection);
 OFF : upper tank water temperature $T3 \geq 10^{\circ}\text{C}$ or the unit is turned on.

 *When the E-heater button on the control panel has been turned on manually, on the display TS2 (E-heater off temperature) appears and it can be directly modified instead of TS1 (tank setting temperature).*

11.4.7 ON/OFF contact

When ON/OFF contact is closed, and the controller is ON, the unit can work and the running mode is decided by the setting of the controller.

When ON/OFF contact is closed, but the controller is OFF, the unit can't work.

When ON/OFF contact is opened, but the controller is ON, the unit can't work (with the exception of external pump).

If the controller is ON, and the ON/OFF status is changed from opened to closed, the unit will work by the previous settings of the controller (auto-restart).

If the unit was previously in stand-by, in case the ON/OFF status is changed from opened to closed, the unit remains in stand-by.

A signal/warning in case of remote OFF signal (opened contact) is displayed. In such a way the customer can understand why the unit is not working.

11.4.8 Contact for photovoltaic plant integration

The ON/OFF contact can be configured so that a photovoltaic plant, in max production periods, can be used to obtain the max value of hot water by the unit (set the parameter 35 to 1). When the contact is closed (activation by FV plant), the tank setting temperature TS1 is increased to the max possible value compatibly with working limits that are indicated in Paragraph 17.

11.5 PARAMETER CHECKING AND ADJUSTMENT

Some parameters can be checked and adjusted by the controller. Below is the parameter list.

Parameter no.	Visibility U=user I=installer	Description	Range	Default	Remarks
0	I/U	Tank water setting temp. (TS1)	10 ~ 65°C	55°C	Adjustable (it can be also modified by the user in normal function)
1	I	Water temp. difference TS6	2 ~ 15°C	5°C	Adjustable
2	I	E-heater off tank water temp. (TS2)	10 ~ 75°C	65°C	Adjustable
3	I	E-heater delay time	0 ~ 90	6	t * 5 min, Adjustable
4	I	Week disinfection temperature TS3 (related to upper tank temp T3)	60 ~ 70°C	70°C	Adjustable
5	I	High temp disinfection time t2	30 ~ 90 min	30 min	Adjustable
13	I	Disinfection start up time adjusting	0~23	23	Adjustable
14	I	Pump usage selection	0/1/2	0	Adjustable (0=disabled, 1=sanitary hot water circulation usage, 2=solar water circulation usage)
15	I	Water circulation temp. setting	15 ~ 50°C	35°C	Adjustable
16	I	Offset for sanitary hot water circulation	1 ~ 15°C	2°C	Adjustable
17	I	Water difference temp. for solar pump restart	5 ~ 20°C	5°C	Adjustable
18	I	Offset for solar water circulation	1 ~ 4°C	2°C	Adjustable
19	I	Low outside temp. electrical heater activation	0/1	1	Adjustable 0=off, 1=on
20	I	Electrical heater activation during defrosting	0/1	1	Adjustable 0=off, 1=on
21	I	Disinfection period	1 ~ 30 days	7 days	Adjustable
32	I	E-heater activation for heat pump integration	0/1	1	Adjustable 0=off, 1=on
33	I	E-heater activation hysteresis	1 ~ 10°C	3°C	Adjustable
35	I	ON/OFF contact configuration	0/1	0	0=on/off 1=photovoltaic
A	U	Lower tank temp T2	0 ~ 99°C		Actual testing value. Error code P1 will be shown in case of a malfunction
B	U	Upper tank temp T3	0 ~ 99°C		Actual testing value. Error code P2 will be shown in case of a malfunction
C	U	Coil temp.	-15 ~ 99°C		Actual testing value. Error code P3 will be shown in case of a malfunction
D	U	Return gas temp.	-15 ~ 99°C		Actual testing value. Error code P4 will be shown in case of a malfunction
E	U	Ambient temp.	-15 ~ 99°C		Actual testing value. Error code P5 will be shown in case of a malfunction
F	U	Hot sanitary/solar water temp.	0 ~ 125°C		Actual testing value. Error code P6 will be shown in case of a malfunction, no error if parameter14=0
G	U	EXV open steps	10 ~ 47 step		N*10 step
H	U	Effective water set for heat pump	10 ~ 65°C		If the working of the unit exceeds the region that is indicated in Paragraph 17 for high water and air temperatures, the effective water set is automatically lowered on respect of TS1 that was set by the user.

11.6 MALFUNCTIONING OF THE UNIT AND ERROR CODES

When an error occurs or the protection mode is set automatically, the circuit board and the wired controller will both display the error message.

Protection/ Malfunction	Error code	LED indicator	Possible reasons	Corrective actions
Standby		Dark		
Normal running		Bright		
Lower tank water temp. sensor failure	P1	☆● (1flash 1 dark)	1) The sensor open circuit 2) The sensor short circuit	1) Check the sensor connection 2) Replace the sensor
Upper tank water temp. sensor failure	P2	☆☆● (2 flashes 1 dark)	1) The sensor open circuit 2) The sensor short circuit	1) Check the sensor connection 2) Replace the sensor
Evaporator coil temp. sensor failure	P3	☆☆☆● (3 flashes 1 dark)	1) The sensor open circuit 2) The sensor short circuit	1) Check the sensor connection 2) Replace the sensor
Return gas temp sensor failure	P4	☆☆☆☆● (4 flashes 1 dark)	1) The sensor open circuit 2) The sensor short circuit	1) Check the sensor connection 2) Replace the sensor
Ambient temp. sensor failure	P5	☆☆☆☆☆● (5 flashes 1 dark)	1) The sensor open circuit 2) The sensor short circuit	1) Check the sensor connection 2) Replace the sensor
Hot Sanitary / Solar temp. sensor failure	P6	Dark	1) The sensor open circuit 2) The sensor short circuit	1) Check the sensor connection 2) Replace the sensor
Situation of remote on/off signal	P7	Dark	When remote signal is on, no P7 will be showed on the controller, when remote signal is off, P7 will be displayed. It is not an error code, but a situation for remote on/off signal.	
T6 too high temp.protection	P8	Dark	1) T6 too high temp. 2) T6 sensor has problem	1) P8 appears at 125°C and disappears at 120°C 2) Check and if it's necessary replace the sensor
High pressure protection (HP Switch)	E1	☆☆☆☆☆● (6 flashes 1 dark)	1) Too high air inlet temp 2) Less water in the tank 3) The electronic expansion valve assembly blocked 4) Too much refrigerant 5) The HP switch damaged 6) The uncompressed gas is in refrigerant system	1) Check if the air inlet temp is over the working limit 2) Check if the tank is full of water. If not, charge water 3) Replace the electronic expansion valve assembly 4) Discharge some refrigerant 5) Replace a new switch 6) Discharge and then recharge the refrigerant
Low pressure protection (LP Switch)	E2	☆☆☆☆☆☆● (7 flashes 1 dark)	1) Too low air inlet temp 2) The electronic expansion valve assembly blocked 3) Too less refrigerant 4) The LP switch damaged 5) The fan assembly can not work	1) Check if the air inlet temp is over the working limit 2) Replace the electronic expansion valve assembly 3) Charge some refrigerant 4) Replace a new switch 5) Check if the fan working when the compressor working. If not, some problems with the fan assembly
Over heat protection (T85°C Switch)	E3	☆☆☆☆☆☆☆● (8 flashes 1 dark)	1) Too high tank water temp 2) The T85°C switch damaged	1) If the tank water temp is over 85°C, the switch will open and the e-heater will stop for protection. After the water comes to normal temp, the protection is auto-reset 2) Replace a new switch
Flow switch	E5	☆☆☆☆☆☆☆☆● (9 flashes 1 dark)	No water flow detected: 1) Pump not powered 2) Pump malfunction 3) Dirty water filter 4) Flow switch malfunction	1) Check pump power supply 2) Verify pump electrical connections and pump rotation. If necessary replace the pump 3) Clean the filter 4) Check the flow switch contacts and functioning
Defrost	Defrosting indicate	☆☆☆☆☆☆☆☆ (all long flashes)		
Communication failure	E8	Bright		

12 MAINTENANCE AND PERIODICAL CONTROLS

	<p>WARNING: All the operations described in this chapter HAVE TO BE CARRIED OUT BY TRAINED STAFF ONLY. Before any operation or before entering the inner components of the unit, be sure that the power supply is disconnected. The compressor's head and discharge piping are usually at high temperature levels. Be very careful when operating in their surroundings. Aluminium coil fins are very sharp and can cause serious wounds. Be very careful when operating in their surroundings. After maintenance operations, re-install the cover panels, and fix them by means of screws where necessary.</p> <p>WARNING: The unit should be installed so that adequate clearance is available for maintenance and repair. The warranty does not cover costs related to platforms or handling equipment necessary for any maintenance.</p>
	<p>The refrigerant circuits must not be filled with different gas other than that indicated on the nameplate. The use of a different refrigerant can cause severe damage to the compressor.</p> <p>It's forbidden to use oils other than those specified in this manual. The use of a different oil can cause serious damage to the compressor.</p>
	<p>It is recommended to set a lower temperature to decrease the heat release, prevent scale and save energy if the outlet water is sufficient.</p>

It is a good rule to carry out periodic checks in order to verify the proper operation of the unit:

OPERATION	1 month	4 months	6 months
Check the water supply and air vent frequently, to avoid lack of water or air in the water loop.	x		
Check out that safety and control devices work correctly.	x		
Check out possible oil leakage from compressor.	x		
Check out possible water leakages from the hydraulic circuit.	x		
Check out the proper working of the external flow switch (if it is installed).	x		
Clean the metallic filters of the hydraulic circuit to keep a good water quality. Lack of water and dirty water can damage the unit.	x		
Clean the finned coil of the heat exchanger by means of compressed air (it's recommended to keep the unit in a place where it is dry and clean, and which has good ventilation).	x		
Check the correct operation of the electric heater for the purpose of anti-Legionella cycle(*). Be sure to make a diagnosis with samples of water token from the critical points the whole hydraulic circuit.		x	
Check out that all the terminals on the electric board as well as on the terminals of the compressor are properly fixed.		x	
Make sure the electrical components are good. If there is a damaged part or a strange smell, please replace it in time.		x	
Tightening of water connections.		x	
Keep the unit clean by means of soft damp cloth.		x	
It is recommended to clean the tank and e-heater regularly to keep an efficient performance.		x	
Clean any external air filter regularly to keep an efficient performance.		x	
Correct voltage.			x
Correct absorption.			x
Check each part of the unit and the pressure of the system. Replace the defect part if there is any, and recharge the refrigerant if it is required.			x
Check the operating pressure, and superheat and subcooling			x
Check of the efficiency of circulation pump.			x
If the heat pump is not used for a long time, please drain out all the water from the unit and seal the unit to keep it good. Please drain the water from the lowest point of the boiler to avoid freezing in winter. Water recharge and full inspection on the heat pump is required before it is restarted.			x
Check and if necessary replace the magnesium stick.			every year

(*) Checking the correct operation of the electric heater: The thermostat control scroll wheel situated on board of the electric heater must be turned all counterclockwise. To test the activation of the electric heater, press the button and check with the tank temperature increasing.

12.1 ENVIRONMENTAL PROTECTION

According to the norms dealing with the use of depleting stratospheric ozone substances, it is forbidden to release refrigerants fluids in the atmosphere. They have to be collected and delivered to the seller or to proper gathering points at the end of their operating life. Refrigerant R134A is mentioned among controlled substances and for this reason it has to be subjected to the mentioned norms. **A particular care is recommended during service operations in order to reduce as much as possible any refrigerant loss.**



This equipment contains R134a refrigerant in the amount as stated in the specification. Do not vent R134a into the atmosphere: R134a, is a fluorinated greenhouse gas with a Global Warming Potential (GWP) = 1430. It should only be serviced or dismantled by professional trained personnel.

13 TROUBLESHOOTING

This section provides useful information for diagnosing and correcting certain troubles which may occur. Before starting the troubleshooting procedure, carry out a thorough visual inspection of the unit and look for obvious defects such as loose connections or defective wiring.

Before contacting your local dealer, read this chapter carefully, it will save you time and money.



When carrying out an inspection on the electrical box of the unit, always make sure that the main switch of the unit is switched 'off'.

The guidelines below might help to solve your problem. If you cannot solve the problem, consult your installer/local dealer.

- No image on the controller (blank display). Check if the main power is still connected.
- One of the error codes appears, consult your local dealer.
- The scheduled timer does work but the programmed actions are executed at the wrong time (e.g. 1 hour too late or too early). Check if the clock and the day of the week are set correctly, adjust if necessary.

14 WHEN THE UNIT GOES OUT OF SERVICE

Once the unit is arrived at the end of its life cycle and needs to be removed or replaced, the following operations are recommended:

- the refrigerant has to be recovered by trained people and sent to proper collecting centre;
- compressors' lubricating oil has to be collected and sent to proper collecting centre;
- the frame and the various components, if not serviceable any longer, have to be dismantled and divided according to their nature, particularly copper and aluminium, which are present in conspicuous quantity in the unit.

These operations allow easy material recover and recycling process, thus reducing the environmental impact.

15 DISPOSAL REQUIREMENTS

Dismantling of the unit, treatment of the refrigerant, of oil and of other parts must be done in accordance with relevant local and national legislation.



Your product is marked with this symbol. This means that electrical and electronic products shall not be mixed with unsorted household waste.

Do not try to dismantle the system yourself: the dismantling of the system, treatment of the refrigerant, of oil and other parts must be done by a qualified installer in accordance with relevant local and national legislation.

Units must be treated at a specialized treatment facility for re-use, recycling and recovery. By ensuring that this product is disposed off correctly, you will help to prevent potential negative consequences for the environment and human health. Please contact the installer or local authority for more information.

16 TECHNICAL CHARACTERISTICS

TECHNICAL DATA		SHW 200	SHW 300S
Power supply	V/Ph/Hz	220-240/1/50	
Water tank real capacity	L	228	278
Heating capacity	W	1870* (+1200**)	
Rated power input	W	503* (+1200**)	
Nominal current	A	2.23* (+5.2**)	
COP	W/W	3.72*	
Max power input	W	765 (+1200**)	
Max current	A	3.5 (+5.2**)	
Max. outlet water temperature (without using E-heater)	°C	65	
Max. water temperature	°C	75**	
Min. water start temperature	°C	10	
Ambient working temp.	°C	-10 ~ +43	
Refrigerant max. discharge pressure	bar	26	
Refrigerant max. suction pressure	bar	6	
Refrigerant type		R134a	
Refrigerant charge	g	920	
Compressor	Type	Rotary	
	Brand	Toshiba	
	Model	PJ125G1C-4DZDE	
	Compressor oil	ESTER OIL VG74, 400 mL	
Fan motor	Type	Asynchronous motor	
	W	80	
	RPM	1250	
Air flow without air static pressure	m ³ /h	450	
Air flow with 60 Pa of air static pressure	m ³ /h	350	
Duct diameter	mm	177 (Fit flexible 180 mm duct)	
Max allowed pressure of tank	bar	10	
Inside body material of tank		S235JR with double layer vetrification	
Auxiliary electrical heater	kW	1.2	
Electronic expansion valve		yes	
Magnesium stick		yes	
Heat pump heat exchanger material (condenser)		Aluminium alloy	
Solar exchanger coil surface	m ²	/	1,2
Auxiliary exchanger coil surface	m ²	/	/
Solar exchanger coil flow rate***	m ³ /h	/	1,2
Auxiliary exchanger coil flow rate***	m ³ /h	/	/
Exchanger coil max. pressure	bar	/	6
Exchanger coil material		Pickled S235JR	
Cold water inlet	inch	G 1"female	
Hot water outlet	inch	G 1"female	
Solar heat source inlet/outlet	inch	/	G 1"female
Auxiliary heat source inlet/outlet	inch	/	/
Condensed water outlet		0,3 mt. Φ22 mm plastic flexible pipe	
Drainage	inch	To be installed externally	
IP protection class		IPX1	
Net Dimensions	mm	φ654x1638	φ654x1888
Packing Dimensions	mm	700x700x1760	700x700x2010
Net Weight	Kg	98.0	121.5
Weight with full water	Kg	326.0	399.5
Gross Weight	Kg	112.0	136.5
Noise level ****	dB (A)	46	
NOTES:			
* Capacity and power input based on the following conditions: ambient temperature 20°C, water temperature from 15°C to 55°C (these data are obtained by internal laboratory tests based on the uniform reintegration of the tank temperature).			
**Related to the supplementary e-heater. During disinfection, the water temp could be up to 70°C by electrical heater			
*** values referring to integration with boiler in accordance with DIN 4708 norms (80/60°C on primary circuit, 10/45°C on secondary circuit)			
**** measured in free field at 1 m from the unit according to EN 12102 standard			

17 WORKING LIMITS OF HEAT PUMP

It's recommended that the unit may work inside the working limits reported here below, in order to avoid the possible intervention of safety devices.

In each case, regarding high temperatures (water temperature between 47 and 65°C, air temperature between 25 and 43°C), if the user sets a temperature that is out of the working envelope, the heat pump adapts automatically its water set to the limits indicated in the diagram here below.

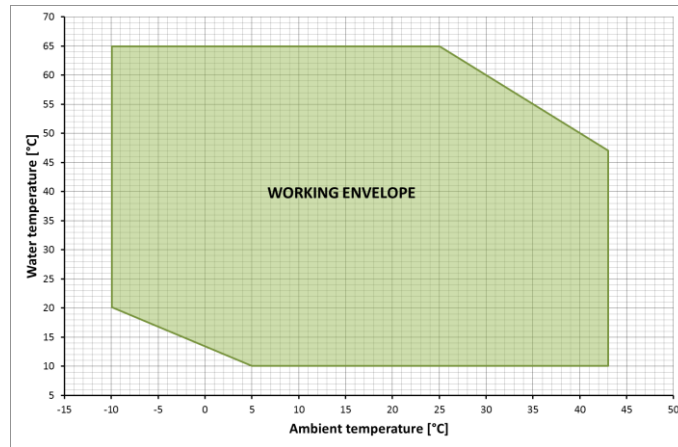

Here below the fixed sets of the pressure switches:

- HP switch: OFF=26 bar, ON=16 bar
- LP switch: OFF=0,2 bar, ON=1 bar

18 WIRING DIAGRAM

Please refer to the wiring diagram on the electric box.

18.1 STANDARD CONNECTION

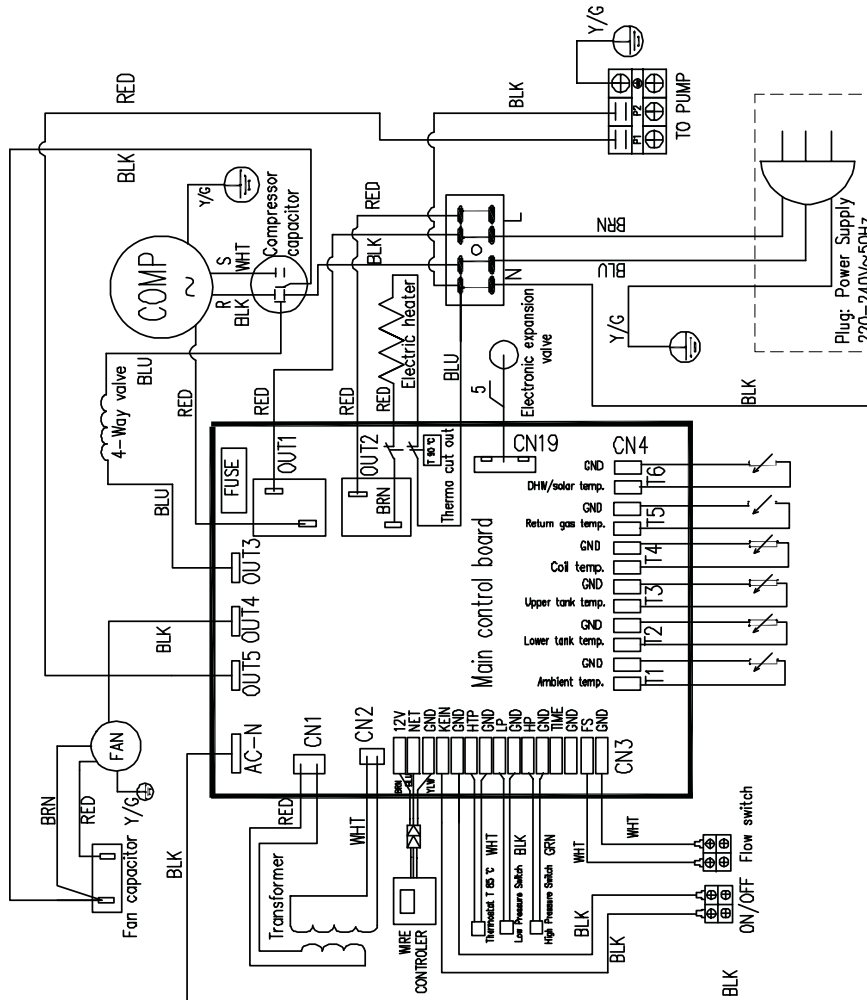

Note:
BLK, BLU, BRN, GRN, ORG, RED, WHT, Y/G, YLW – Colours of the wires

18.2 CONNECTION OF AN AUXILIARY HEAT SOURCE

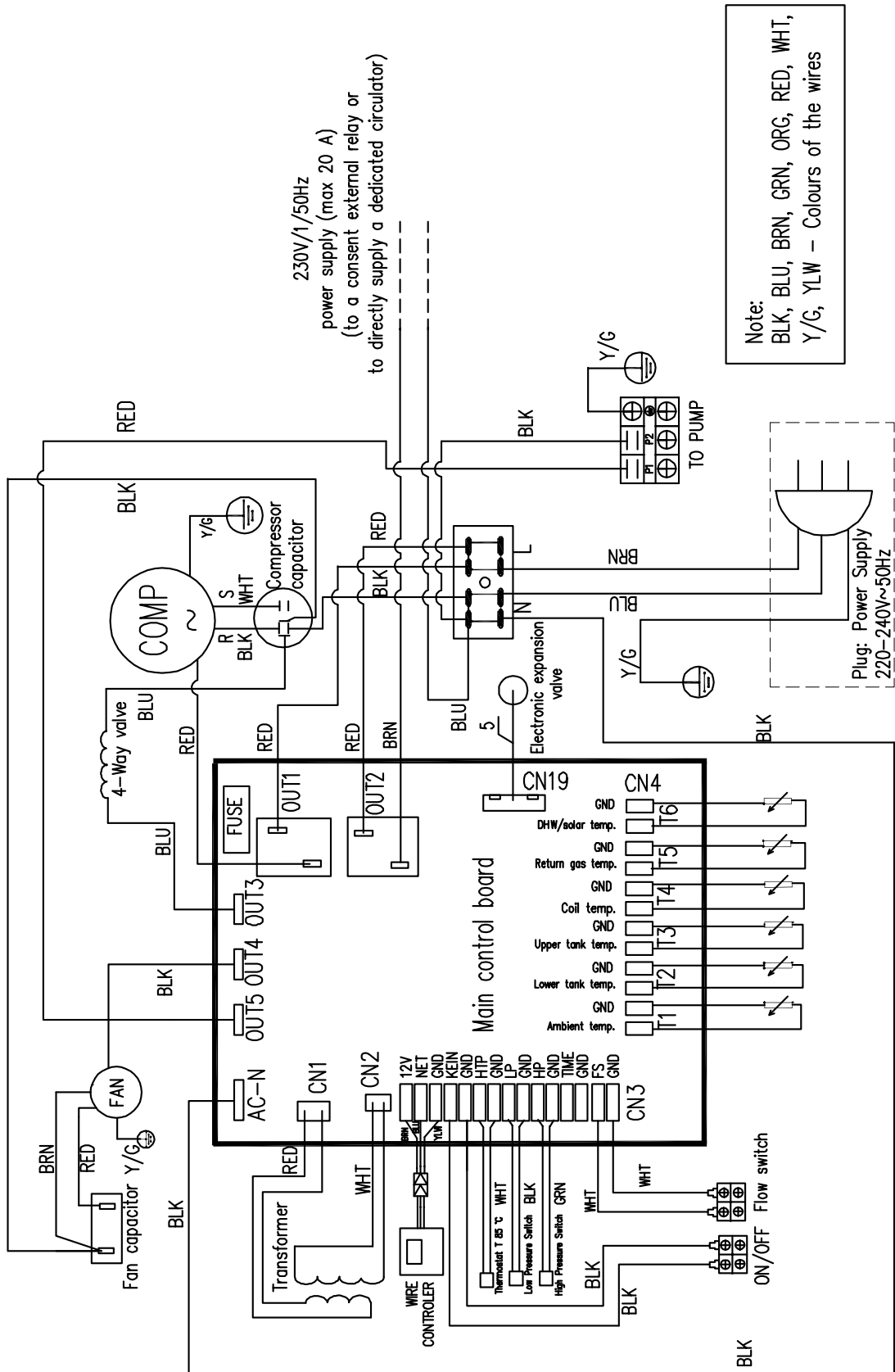

18.3 CONNECTION OF AN AUXILIARY HEAT SOURCE BY MEANS OF AN EXTERNAL SWITCH

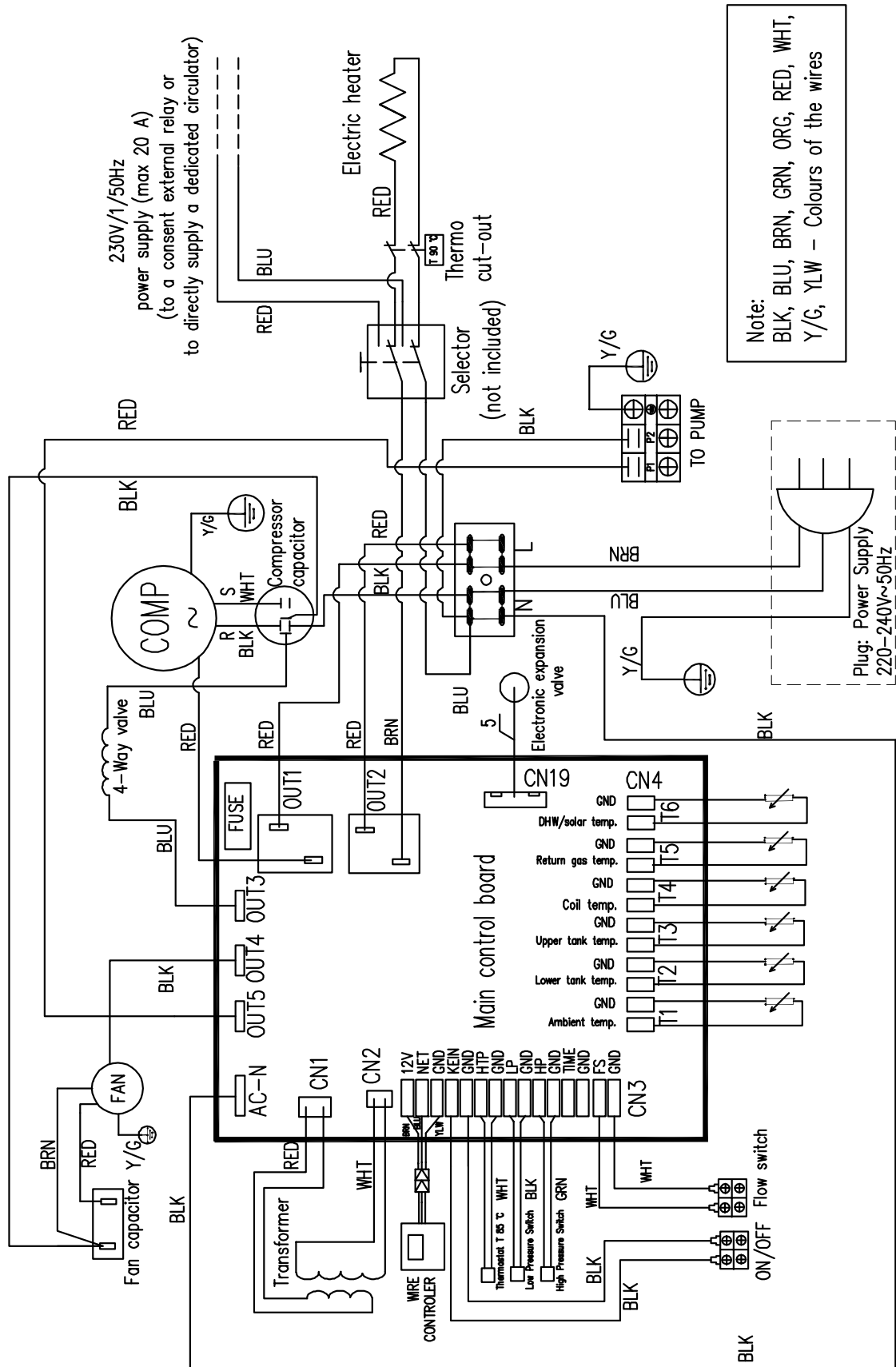

19 FICHE ACCORDING TO REGULATION (EU) No 812/2013

Modelli / Models		SHW 200	SHW 300S
Profilo di carico dichiarato / Declared load profile		L	L
Classe di efficienza energetica di riscaldamento dell'acqua Water heating energy efficiency class		A	A
Efficienza energetica di riscaldamento dell'acqua Water heating energy efficiency	Aria interna +20°C / Indoor air +20°C	108 %	114 %
	condizioni climatiche più calde (+14°C) under warmer climate condition	101 %	106 %
	condizioni climatiche medie (+7°C) under average climate conditions	95 %	100 %
	condizioni climatiche più fredde (+2°C) under colder climate conditions	92 %	97 %
Consumo annuo di energia in termini di energia finale Annual energy consumption in terms of final energy	Aria interna +20°C / Indoor air +20°C	944 kWh	898 kWh
	condizioni climatiche più calde (+14°C) under warmer climate condition	1011 kWh	962 kWh
	condizioni climatiche medie (+7°C) under average climate conditions	1075 kWh	1022 kWh
	condizioni climatiche più fredde (+2°C) under colder climate conditions	1110 kWh	1055 kWh
Impostazione temperatura termostato Thermostat temperature settings		55°C	55°C
Livello di potenza sonora all'interno L _{WA} Sound power level, indoor L _{WA}		59 dB(A)	59 dB(A)
Precauzioni di installazione e manutenzione Precautions for installation and maintenance		Per le indicazioni relative all'installazione e alla manutenzione riferirsi ai capitoli dedicati nel manuale utente-installatore. Read precautions for installation and maintenance at specific chapters on user's and installation's manual.	

20 TECHNICAL PARAMETERS ACCORDING TO REGULATION (EU) No 814/2013

Modelli / Models		SHW 200	SHW 300S
Consumo quotidiano di energia elettrica Q _{elec} Daily electricity consumption Q _{elec}	Aria interna +20°C / Indoor air +20°C	4,360 kWh	4,149 kWh
	condizioni climatiche più calde (+14°C) under warmer climate condition	4,666 kWh	4,440 kWh
	condizioni climatiche medie (+7°C) under average climate conditions	4,953 kWh	4,713 kWh
	condizioni climatiche più fredde (+2°C) under colder climate conditions	5,113 kWh	4,865 kWh
Profilo di carico dichiarato / Declared load profile		L	L
Livello di potenza sonora all'interno / Sound power level, indoor L _{WA}		59 dB(A)	59 dB(A)
Acqua mista a 40°C V40 / Mixed water at 40°C V40		235 l	315 l
Efficienza energetica di riscaldamento dell'acqua Water heating energy efficiency	Aria interna +20°C / Indoor air +20°C	108 %	114 %
	condizioni climatiche più calde (+14°C) under warmer climate condition	101 %	106 %
	condizioni climatiche medie (+7°C) under average climate conditions	95 %	100 %
	condizioni climatiche più fredde (+2°C) under colder climate conditions	92 %	97 %

The technical data and the aesthetic characteristics of the products can undergo changes. Olimpia Splendid reserves the right to modify them at any time without notice